

8

7

6

5

4

3

2

1

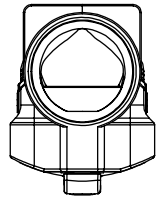
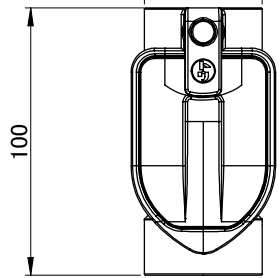
 $\phi 44$

100

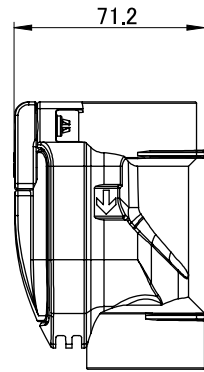

71.2

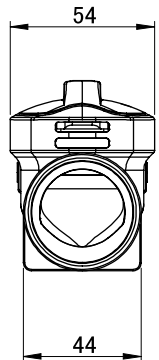

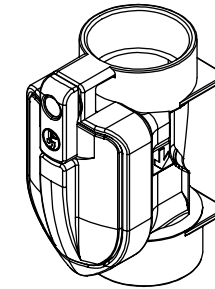
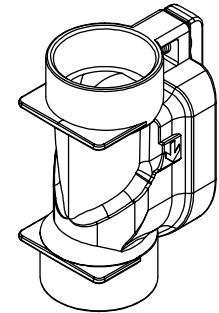
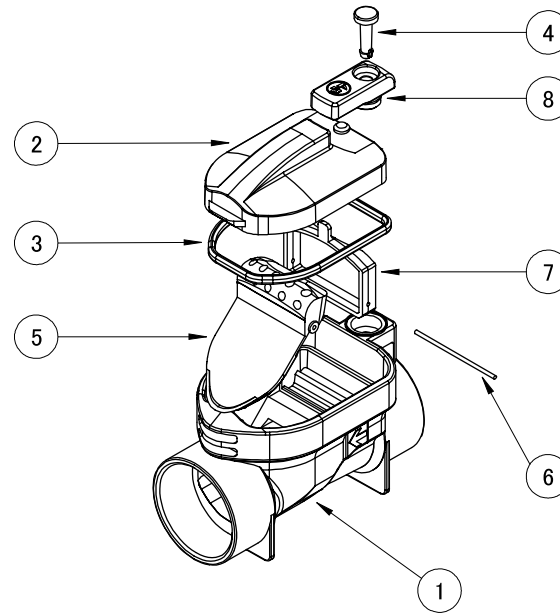

54

44



※30-25用アダプタ、25-20用アダプタ各2個ずつ同梱(塩ビ製市販品)

パルーン番号	部品番号	部品名	数量	材料	色	備考
①	TK-ACV30-0001	ACV-V-30 本体	1			
②	TK-ACV30-0002	ACV-V-30 蓋	1			
③	TK-ACV30-0003	ACV-V-30 Oリング	1			
④	TK-ACV30-50-0004	ACV-V-30-50 ピン	1			
⑤	TK-ACV30-0005	ACV-V-30 弁	1			
⑥	TK-ACV30-0006	ACV-V-30 シャフト	1			
⑦	TK-ACV50-0007	ACV-V-30 軸受けガイド	1			
⑧	TK-ACV30-0008	ACV-V-30 ロックキャップ	1			

				記号: MARK	材料: MATERIAL	公差: TOLERANCES (JIS B0405)		個数: Q'TY	処理: TREATMENT/FINISH		
				年月日: DATE		GRADE/RANGE(mm)	M / ±				
				承認: APPROVED BY		承認: APPROVED BY	検図: CHECKED BY	名称: TITLE			
				変更者: REVISED BY		設計: DESIGNED BY	製図: DRAWN BY				
				記事: CONTENTS	 東光器材株式会社	初版年月日: FIRST DATE	2020.3.11	30~120	0.3	部品番号: DRAWING NO. TK-ACV30-ASSY	変更回数 REV.MARK 
						120~400	0.5				
						400~1000	0.8				

8

7

6

5

4

3

2

1