

AD-3255

INSTRUCTION MANUAL

Ultrasonic Thickness Gage

AND

A&D Company, Limited

1WMPD4003292A

Note

- No part of this publication may be reproduced, transmitted, transcribed, or translated into any language in any form by any means without the written permission of A&D Company, Limited.
- The contents of this manual and the specifications of the instrument covered by this manual are subject to change for improvement without any notice and obligation on the part of the manufacturer.

© 2017 A&D Company, Limited All rights reserved.

- ULTRAGEL II[®], HIGH Z[®] and SONO[®] are registered trademarks of the Magnaflux company.

Contents

1.	Safety Information	2
1-1-1.	Meaning of Alert Indications	2
1-1-2.	Cautions Concerning Safety Indications.....	2
1-1-3.	Cautions Concerning Performance	3
2.	Introduction	4
2-1.	Features	4
3.	Overview " <i>Unpacking, Names, Operation & Response</i> "	6
3-1.	Unpacking	6
3-2.	Names	7
3-3.	Operation and Response.....	8
4.	Measurements.....	11
4-1.	Preparation.....	11
4-2.	Basic Measurement.....	12
4-2-1.	Primary Operation.....	12
4-2-2.	Probe – Zero Function	14
4-2-3.	Switching the Display Resolution	15
4-2-4.	Switching Measurement Modes	15
4-3.	Sound Velocity Calibration.....	16
4-3-1.	Use of Sound Velocity Calibration	16
4-3-2.	Calibration of Known Sound Velocities.....	17
4-3-3.	Calibration of Unknown Sound Velocities	17
4-3-4.	Two point calibration for Sound Velocities	18
4-3-5.	Initialization of Sound Velocities	19
4-3-6.	Pre-installed Sound Velocities.....	20
5.	Information and Cautions	21
5-1.	Battery	21
5-2.	Transducer	21
5-3.	Measurement of the Tube & Pipe	24
5-4.	Couplant.....	26
5-5.	Measurement Principle.....	27
5-6.	Reference Data of Sound Velocities	28
6.	Specifications	29





1. Safety Information

This section describes information to use the AD-3255 safely and to prevent injury.

1-1-1. Meaning of Alert Indications

All safety messages are identified by the following of ANSI Z535.4. Each alert indication has the following meaning.

Warning Definitions

 Warning	A potentially hazardous situation which, if not avoided, could result in death or serious injury.
 Caution	A potentially hazardous situation which, if not avoided, may result in minor or moderate injury or damage to the instrument.
	This is a hazard alert mark.
	Operation is prohibited.

Others

Caution	An important description for proper use of the instrument.
Note	The information that helps users operate the instrument.

1-1-2. Cautions Concerning Safety Indications

 Caution	
Repair	Only authorized individuals may open the case and repair the AD-3255. Loss of data or malfunctions may result from opening the case. Contact your local dealer or our service department to resolve the issue.
Failure	Should the AD-3255 experience a malfunction, stop usage immediately, post a notice indicating " <i>Out of Order</i> " on the AD-3255 and move it to place where it will not be used by mistake. Continued usage of it in this state is very dangerous. Contact your local dealer for repair.

1-1-3. Cautions Concerning Performance



- Gently use the AD-3255 because of the precision instrument. Strong impacts could result in a malfunction.
- Use the accessory carrying case for transport.
- The main unit and transducer are calibrated as pair in the factory. Failure to use an authorized transducer may result in incorrect thickness measurements. Always keep the main unit and transducer as pair when asking for a repair.
- The AD-3255 is not waterproof. Avoid water, moisture, oil and dust. Avoid an extreme temperature change or impact. Do not immerse the transducer in water or oil.
- Avoid contaminating the transducer connector with water, oil and dust.
- Use the accessory strap as needed.
Example: Tie the strap to the main unit to avoid losing the test piece.
Tie the strap to the main unit to prevent the set from being stored in a piecemeal fashion.
- Do not pull excessively on or sharply bend the transducer cable.
- Clean the main unit using a lint free cloth that moistened with water and neutral detergent. Clean the connectors and electrical terminals using a dry lint free cloth.
- Operating temperature range : 0 [°C] to 50 [°C]
- Remove the batteries from the main unit when the AD-3255 is not used for a long time.

2. Introduction

- Congratulations on purchasing an ultrasonic thickness gage AD-3255 of A&D Company, Limited. We recommend that you read through this manual carefully before using the AD-3255 for the first time. Keep the manual nearby for reference.

2-1. Features

- The AD-3255 can measure the thickness of various materials using a principle similar to sonar, displays the thickness value in 0.1 [mm] or 0.01 [mm] units, and is equipped with a multimode feature.
- The multimode feature
 - **Pulse – Echo Mode**
Use this mode for basic measurements or detection of flaws, cracks and pits.
 - **Echo – Echo Mode**
When measuring the thickness, use this mode to eliminate errors concerned with measuring coating and paint thickness. Use the optional transducer, AD-3255-04.
- The sampling mode
 - **Single Point Mode**
This mode can measure single point thickness where the transducer is placed.
Sampling rate : 7 [times/ second]
 - **Scan Mode**
This mode can display a minimum value from thickness in areas where the transducer has been moved.
Sampling rate : 16 [times/ second]

- Probe–Zero Function
The AD–3255 is equipped with a probe–zero function to calibrate the zero point of the transducer in the pulse – echo mode.
- The sound velocity can be calibrated with a single point calibration, two point calibration or numerical input.
- The coupling state symbol  indicates the state of the transducer contacting the material surface.
- The AD–3255 can store user settings and calibration data.
- The battery indicator  indicates the battery power.
- The AD–3255 is equipped with an automatic power-off function: When no operation is performed for approximately 5 minutes, the display blinks for 20 seconds and then the power is turned off.
- The AD–3255 can measure the thickness of other metal, plastic, ceramics, composite materials, epoxy resin, glass and a variety of other materials.

The range of sound velocity:	1000 to 9999 [m/s],
The range of thickness:	0.8 to 200 [mm],
Using the accessory transducer.	

3. Overview "Unpacking, Names, Operation & Response"

3-1. Unpacking

- Upon receiving the product, inspect the main unit and accessories contained in the package. Should anything be missing or damaged, contact and consult your local dealer.

- Use the carrying case for transport.

- Packing list is as follows:

Main unit	1
Test piece "is equivalent to the thickness of 4.00 mm" AD-3255-01	1
Transducer for the pulse – echo mode AD-3255-02	1
Carrying case	1
Empty bottle for the couplant	1
Strap	1
Instruction manual "This manual"	1

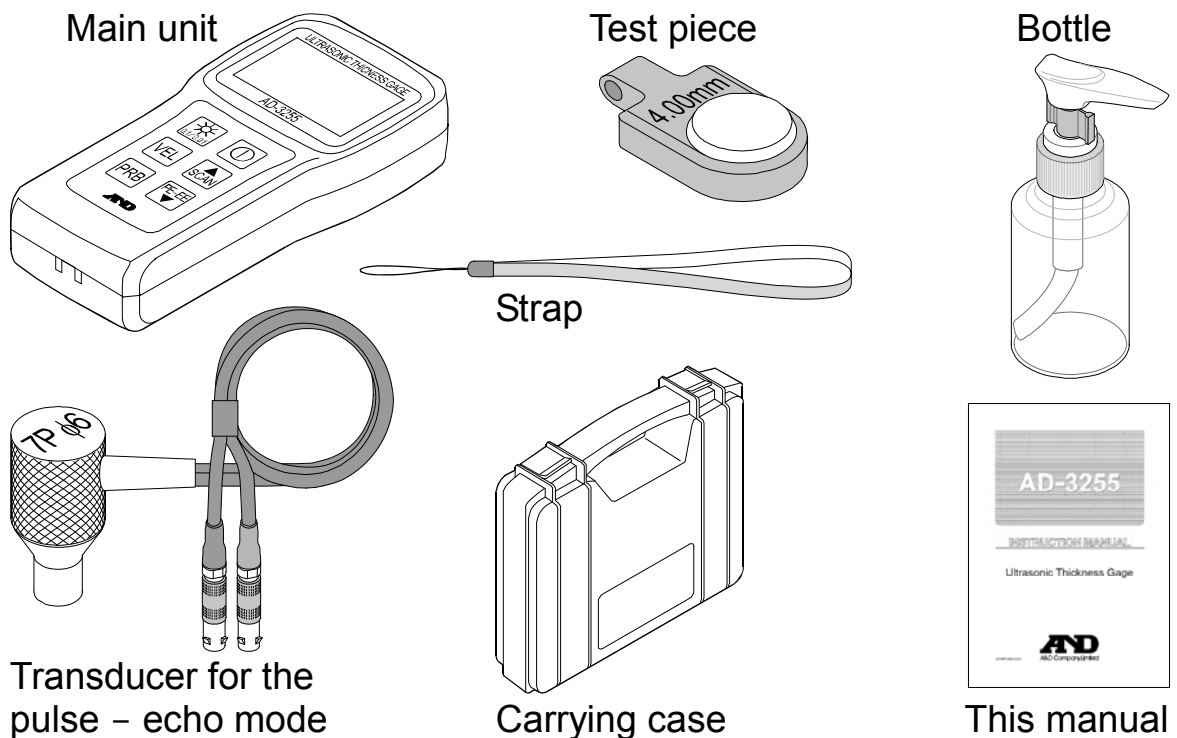



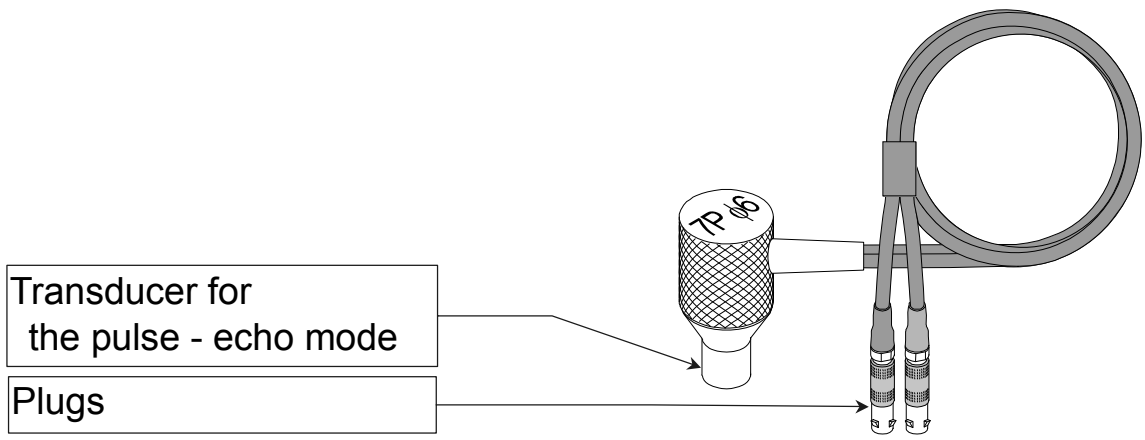
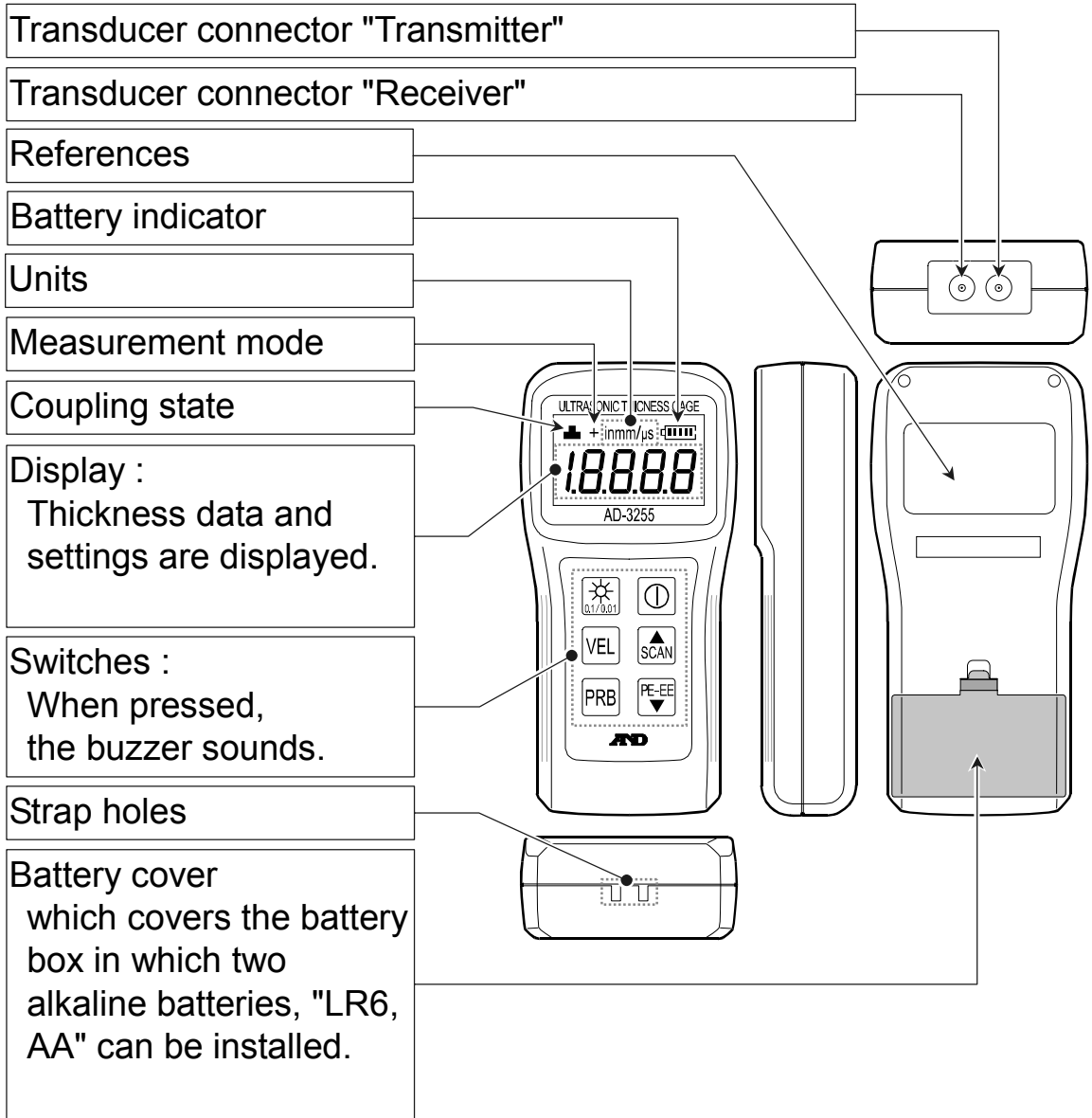







3-2. Names

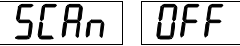
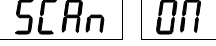

3-3. Operation and Response



Switches

	<ul style="list-style-type: none"> Turns the AD-3255 on/off.
	<ul style="list-style-type: none"> Turns the backlight on/off. Changes the display resolution to 0.1 [mm] or 0.01 [mm]. Press the  switch while pressing and holding the  switch after turning off the main unit.
	<ul style="list-style-type: none"> Enters the sound velocity settings from the measurement. Returns the measurement from the sound velocity settings.
	<ul style="list-style-type: none"> Starts the probe - zero function from the measurement. Specifies a connected transducer in the probe - zero function.
	<ul style="list-style-type: none"> Increases the parameter in the setting mode. Selects a measurement mode in the measurement. <p>Single point mode Indication  Measures the thickness in the space where the transducer is placed on the material surface. Sampling rate : 7 [times/sec.]</p> <p>Scan mode Indication  Displays a minimum thickness from the measured data in the area where the transducer has been moved. Sampling rate : 16 [times/sec.]</p>
	<ul style="list-style-type: none"> Decreases the parameter in the setting mode. Selects the measurement mode. <p>Pulse - echo mode Hide +, Indication  This mode is for major measurements and can be used to detect a flaw or pit.</p> <p>Echo - echo mode Show +, Indication  This mode can be measure the thickness that is eliminated errors concerned with measuring coating and paint thickness.</p>

Cautions

- Use the optional AD-3255-04 transducer if a thickness is measured using the echo - echo mode.
- The backlight consumes the battery power.
- The AD-3255 can not perform in other modes while the current mode is active or busy. For example :
 - During sound velocity calibrations, the probe-zero function can not be performed.
 - During thickness measurements, numerical input is unavailable.
 - While setting information is displayed, switches cannot be operated.

Coupling Indication



- The AD-3255 can indicate the coupling state between the transducer and material surface. The symbol  indicates stable and measurable contact. The blinking symbol  indicates unstable and weak contact. When the measurement is complete, the buzzer sounds.

Units

- The units of thickness [mm] or sound velocity [m/s] are displayed. The unit [in] is not displayed.



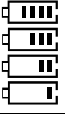

Battery Indicator

- The blocks indicate the state of to the battery.

	Adequate battery power.
	Blocks indicate changes in battery power levels.
	The battery power has been consumed. Replace with two new alkaline batteries, "LR6, AA".

Buzzer

Different buzzer sound types indicate the following:

	Turning on the AD-3255.
	Turning off the AD-3255.
	Initializing sound velocity or when changing display resolution.
	Switch response
	Measuring thickness.

Error Code

<i>E-00</i>	Battery power has been consumed.
-------------	----------------------------------

Contact your local dealer for any error other than error code displayed above.

4. Measurements

4-1. Preparation

Step 1. Install "or Replace" Batteries.

- Open the battery cover.
Install two new alkaline batteries matching polarities "+" and "-" with those of the electrical terminals.
Close the battery cover.

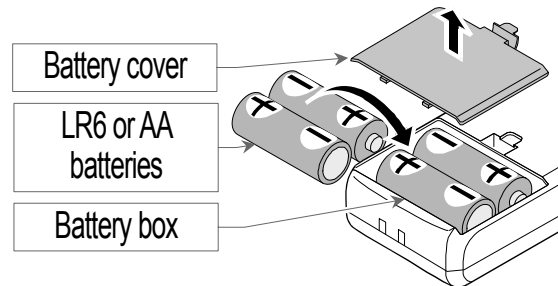

Step 2. Connect Plugs of the Transducer.

- Connect the plugs of the transducer to the connectors on the main unit.
The connector can connect either the transmitter plug or receiver plug.
Clean the plug if couplant is present.

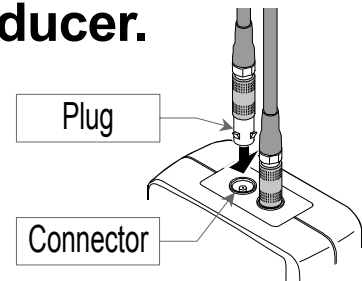

Step 3. Prepare the Couplant.

- Prepare the couplant using the bottle.

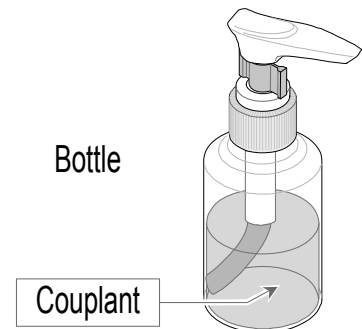

Step 4. Prepare the Test Piece.

- Prepare the accessory test piece with an equivalent thickness of 4.00 mm.
Put the couplant on the surface of the test piece.

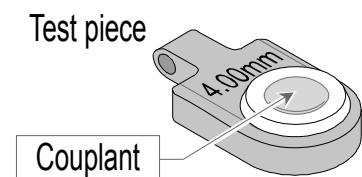

Step 5. Prepare a Material Sample Piece.

- Prepare a sample piece to measure the thickness.
Apply couplant to the surface of the material.

4-2. Basic Measurement

4-2-1. Primary Operation

Step 1. Turn on the Main Unit.

- Press the  switch to turn on the main unit.



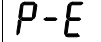

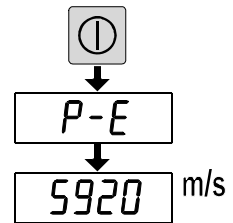

The buzzer sounds "pitt pitt".

The  of the pulse - echo mode is displayed.

The  of "the initial" sound velocity is displayed.



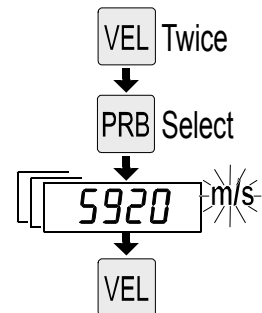

Step 2. Confirm the Sound Velocity "if necessary".

- Press the  switch twice.
- Confirm the  of the sound velocity for the test piece. Select it using the  switch from pre-installed values "or using the  switch and  switch", if necessary.
- Press the  switch to store it.

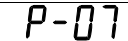

Step 3. Specify the Transducer "if necessary".

- Press the  switch to display the current transducer. Specify the  using the  switch and  switch.

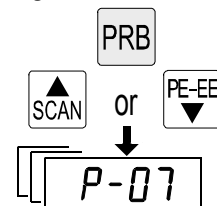

Step 4. Calibrate the Zero Point.

- Contact the transducer to the surface of the test piece coated with couplant. The calibration is finished when the indicator  is displayed, 4.00 [mm] is measured and the buzzer sounds "pitt".

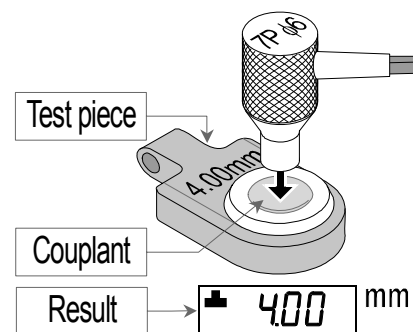

Step 5. **Measure the Material.**

- Contact the transducer to the surface of the material. The indicator  is displayed and the thickness is measured.

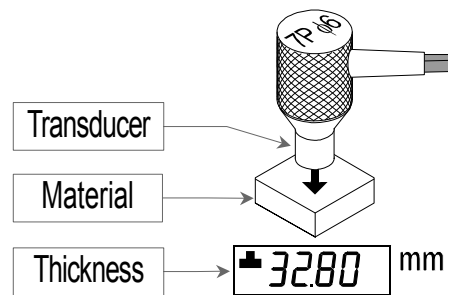

Step 6. **Turn off the Main Unit.**

- Press the  switch to turn off the main unit. The buzzer sounds "pii".

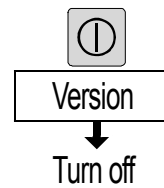

4-2-2. Probe – Zero Function

- Use this function to calibrate the zero point concerning the pulse – echo mode. Don't use this function for the echo – echo mode.

Step 1. Confirm the Sound Velocity "if necessary".

- Press the **VEL** switch twice in the measurement mode.
- Confirm the **5920** of the sound velocity for the test piece. Select it using the **PRB** switch from pre-installed values "or using the **SCAN** switch and **PE-EE** switch", if necessary.
- Press the **VEL** switch to store it.

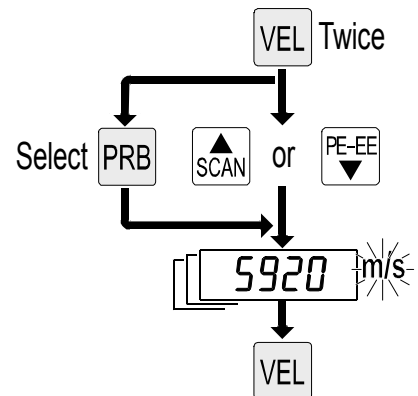

Step 2. Specify the Transducer.

- Press the **PRB** switch to display the current transducer. Specify the **P-07** using the **SCAN** switch and **PE-EE** switch.

<i>P-07</i>	AD-3255-02	Accessory
<i>P-05</i>	AD-3255-03	Option
<i>P5EE</i>	AD-3255-04	Option
<i>P-02</i> <i>HES</i>	Not used	

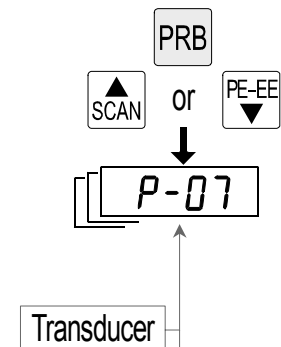

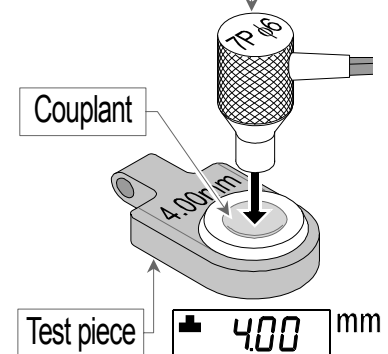

Step 3. Calibrate the Zero Point.

- Contact the transducer to the surface of the test piece coated with couplant. The calibration is finished when the indicator  is displayed, 4.00 [mm] is measured and the buzzer sounds "pitt".





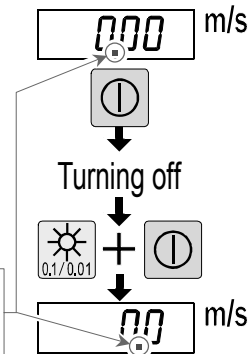

4-2-3. Switching the Display Resolution

- Press the  switch to turn on the main unit while pressing and holding the  switch after turning off the main unit. The display resolution is switched to 0.1 [mm] or 0.01 [mm].

Example:
The display resolution has been exchanged from 0.01 [mm] to 0.1 [mm].

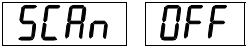

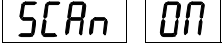
4-2-4. Switching Measurement Modes

- The following modes in the measurement can be selected.
- **Single Point Mode**
 - The  are displayed when the  switch is pressed in the measurement mode. This mode can measure single point thickness where the transducer is placed.
Sampling rate : 7 [times/sec.]
- **Scan Mode**
 - The  are displayed when the  switch is pressed in the measurement mode. This mode can display a minimum value from the thickness in the area where the transducer has been moved. Sampling rate : 16 [times/sec.]
 - In this mode, any brief interruptions "example: a weak contact, no couplant area, etc." less than 2 seconds in the signal will be ignored.
 - When the "blinking symbol " is displayed, and the contact of the transducer is lost for 2 seconds or more, the AD-3255 will display the smallest measurement data.
 - The measurement value blinks 5 times when a minimum value is displayed.
 - The AD-3255 doesn't store the scan mode settings. The single point mode will run when restarting the AD-3255.

4-3. Sound Velocity Calibration

Cautions

- Confirm the 5920 [m/s] to the sound velocity when calibrating the sound velocity using the accessory test piece. The settings are not needed if the sound velocity has not changed.
- Sample piece whose coating or paint has removed is required for both the single point and the two point calibrations. If the sample piece's coating or paint is not removed, a correct thickness value can not be displayed.
- In order to keep the accuracy of the measurement, use sample pieces of known thickness.

4-3-1. Use of Sound Velocity Calibration

- **"The single point calibration"** is the simplest and is commonly used as the calibration procedure that can optimize the linearity in a wide range.
 - The method to input the sound velocity using numerical switches. Refer to "4-3-2. Calibration of Known Sound Velocities".
 - The method to calculate the sound velocity based on known thickness of sample piece. Refer to "4-3-3. Calibration of Unknown Sound Velocities".
- **"The two point calibration"** allows for greater accuracy over a small range by calculating the probe-zero function and sound velocity calibration.
 - Refer to "4-3-4. Two point calibration for Sound Velocities".
- The method to restore to the sound velocity of the test piece.
 - Refer to "4-3-5. Initialization of Sound Velocities".
- The method select a sound velocity from pre-installed values.
 - Refer to "4-3-6. Pre-installed Sound Velocities".

4-3-2. Calibration of Known Sound Velocities

Step 1. Numerical Input of the Sound Velocity.

- Press the **VEL** switch twice in the measurement mode.
- Display the sound velocity using the **PRB** switch from pre-installed value "or using the **SCAN** switch and **PE-EE** switch".
- Press the **VEL** switch to store.
- Refer to "5-6.Reference Data of Sound Velocities" concerning principal sound velocities.

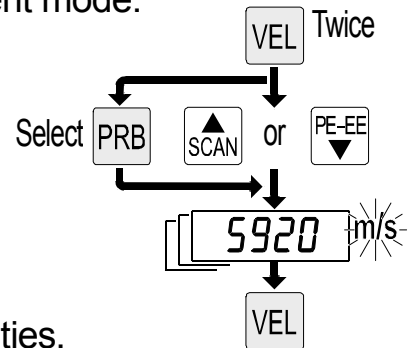

4-3-3. Calibration of Unknown Sound Velocities

- Prepare a sample piece that the thickness is known.

Step 1. Perform the Probe-Zero Function.

- Perform the "4-2-2. Probe – Zero Function".

Step 2. Measure the Thickness of Sample Piece.

- Apply couplant to the surface of the sample piece. Press the transducer against it. The thickness value is displayed. Measure it and remove the transducer
- Remove the transducer from the surface after the measurement.

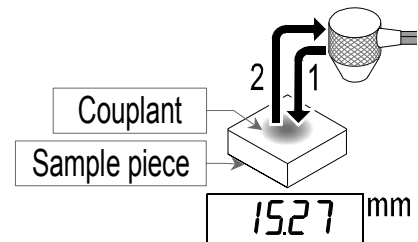

Step 3. Input the Thickness Value.

- Press the **VEL** switch. The mm blinks. Input the thickness value using the **SCAN** switch and **PE-EE** switch.
- Press the **VEL** switch to store. The sound velocity is calculated.
- Press the **VEL** switch to return to the measurement.

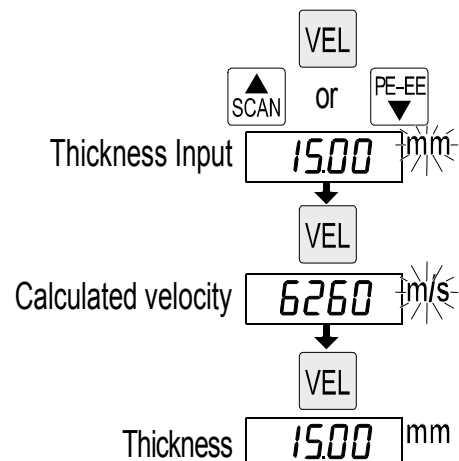

4-3-4. Two point calibration for Sound Velocities

- Prepare a sample piece "or two pieces" whose thickness are known.

Step 1. Perform the Probe-Zero Function.

- Perform the "4-2-2. Probe - Zero Function".

Step 2. Measure the Thickness of the First Point.

- Apply couplant to the first point of the sample piece. Press the transducer against it. The thickness value of the first point is displayed.
- Remove the transducer from the surface after the measurement.

Measure it and remove the transducer

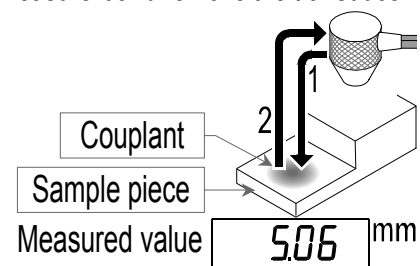

Step 3. Input the Value of the First Point.

- Press the **VEL** switch. The mm blinks. Input the value of the first point using the **SCAN** switch and **PE-EE** switch.
- Press the **PRB** switch to display **10F2** of next step.

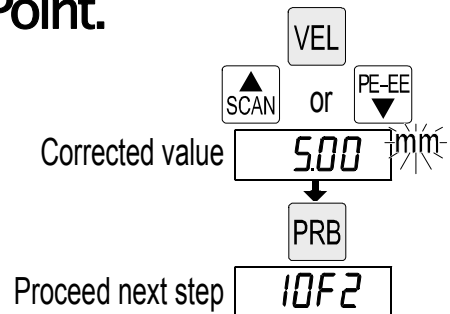



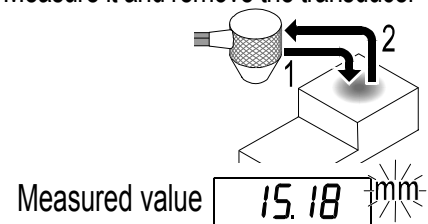

Step 4. Measure the Thickness of the Second Point.

- Apply couplant to the second point of the sample piece. Press the transducer against it. The thickness value of the second point is displayed.
- Remove the transducer from the surface after the measurement.

Measure it and remove the transducer



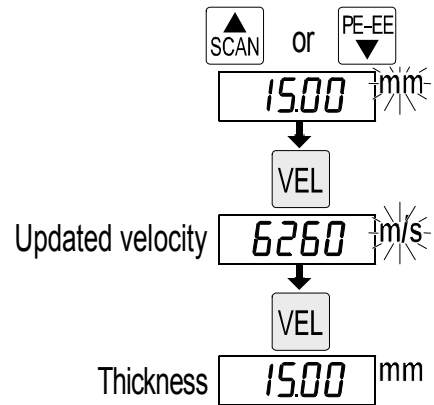

Step 5. Input the Value of the Second Point.

- Input the value of the second point using the  switch and  switch.
- Press the  switch to store and to display an updated sound velocity.
- Press the  switch again so as to exit the calibration mode and perform the measurement with this range.



4-3-5. Initialization of Sound Velocities

- Press the  switch to turn on the main unit while pressing and holding the  switch after turning off the main unit. Release the  switch when the sound velocity is displayed. The 5920 [m/s] is set to the sound velocity after the initialization.

4-3-6. Pre-installed Sound Velocities

- The pre-installed sound velocities are as follows:
Refer to the "5-6. Reference Data of Sound Velocities".
The sound velocity vary in accordance with the temperature and characteristics of the substance.

5920 [m/s]	Iron, Accessory test piece
6260 [m/s]	Aluminum
[m/s]	The latest sound velocity that is stored in the main unit
2720 [m/s]	Acrylic resin
4300 [m/s]	Brass
4700 [m/s]	Copper
5630 [m/s]	Nickel
5740 [m/s]	Stainless steel

Step 1. **Select the Sound Velocity.**

- Press the **VEL** switch twice in the measurement.
- Select a sound velocity using the **PRB** switch.
- Press the **VEL** switch to store a new sound velocity.

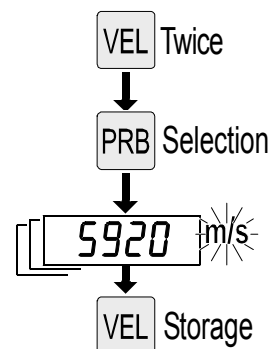

5. Information and Cautions

5-1. Battery

Cautions

- Use the specified battery. Install and replace with new batteries.
- Install two new alkaline batteries matching polarities "+" and "-" with those of the electrical terminals. Incorrect polarities may result in malfunctions or damage.
- Do not charge the battery. Do not short the terminals of the battery. Do not disassemble the battery. Do not throw the battery into the fire. Doing so may cause an explosion of the battery or a leakage from the battery.
- Dispose of the battery properly in accordance with the local regulations concerning environmental protection.
- Keep the battery out of reach of babies or young children.

5-2. Transducer

- **Probe – Zero Function**
We recommend performing this function to maintain the accuracy of the thickness whenever measuring.
- **Appropriate Transducer**
It is an important to select the appropriate transducer for highly accurate or highly reliable measurements. Different type of transducers may be required on the material used. The strength of ultrasonic wave passed through the material is influenced by the following conditions.

□ **The Input Strength of the Ultrasonic Signal**

The stronger the inputted ultrasonic wave is, the stronger the received echo will be. The strength of the input signal is mainly influenced by the size of the emitter of the transducer. Large emitters can transmit stronger energy to the material more than small ones.

□ **Absorption and Scattering**

Ultrasonic waves are capable of traveling through any material but are partially absorbed by them. If the signal of the ultrasonic wave is passed through air bubbles etc. included in the material, the sound wave is scattered. This phenomenon reduces the signal and reduces the performance of the thickness gage that detects the signal. The higher ultrasonic wave frequencies are absorbed and are scattered more than those of lower frequencies. Lower frequencies have weaker directivity than higher ones. The transducer of higher frequency is the better choice to detect the exact location of flaws, cracks or pits.

□ **The State, Roughness and Unevenness of a Surface**

Material shape and the roughness of its surface are causes of measurement failure. It is difficult for ultrasonic waves to penetrate uneven surfaces and will result in unstable measurements or poor reliability. The surface whose thickness is to be measured should be clean and free of any small particulate matter, rust, or dirt. Make the measurement surface clean and free from particles, rust or dirt. If any of these obstructions are present, the transducer cannot make proper contact. In general, clean the surface using a wire brush or sandpaper. In special cases, clean the surface using a rotary sander or grinder. Excessive scraping is not necessary. Measuring the very rough surface like an uneven cast-iron surface is the most difficult. This rough surface affects to the sound wave such that the light passes through the frosted glass. The sound wave is absorbed and scattered in all directions. Not only does the rough surface result in

measurement failure, but it also causes excessive transducer wear. The transducer should be inspected periodically for signs of uneven surface wear. If the surface of the transducer is worn on one side more than another, the sound wave traveling through the material may no longer be perpendicular to the material surface. In this case, an accurate measurement cannot be made.

□ **Holding the Transducer**

Press the top of the transducer using thumb or index finger when measuring. Press the transducer properly and keep the position so that the transducer maintains contact with the surface.

□ **Propagation of Ultrasonic Wave**

The sound velocity is easily influenced by the temperature, state of stress and other physical properties. There are some materials whose sound velocities vary based on the kind of ultrasonic wave and the direction of travel.

□ **Shape of the Transducer**

The appropriate transducer should be selected in accordance with the geometric shape of the measurement area. In this case, it is necessary to select the size of the transducer. Connect the transmitter plug and the receiver plug to the coaxial connectors on the main unit. The plugs can be connected to either the transmitter connector or receiver connector.

□ **Principle of the Probe – Zero Function**

Because there is a distance between the coupling surface and the transmitter element of the transducer, the input position of the coupling surface and the position of the transmitter element does not match. Therefore, an error of the delay time will occur. If the "probe – zero function" is not performed correctly, an error to the thickness measurement will occur. If the "probe – zero function" is performed correctly, the constant error is eliminated and the correct thickness value will be obtained automatically.

❑ **Error Due to Paint or Coating**

If paint or coating on the material is very thick, the thickness of the paint or coating may be included for the measurement.

❑ **Gap of the Transducer**

There is an acoustic barrier "gap" between two hemi-circles inside of the transducer. The ultrasonic wave is transmitted from one of the hemi-circles, its echo is received at the other hemi-circles. Put the material under the center of two hemi-circles.

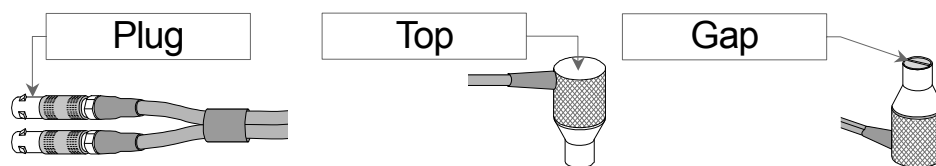

5-3. Measurement of the Tube & Pipe

❑ **Measurement of Pipe and Tube**

The direction of the transducer is important when measuring the wall thickness of a pipe. If the diameter of the pipe is more than approximately 10 cm, it is necessary to match the direction of the acoustic barrier "gap" of the transducer to the perpendicular direction "right angle" of the long axis direction. The measurement of narrow pipes uses two direction measurements. One of the directions is perpendicular to the long axis direction, and the other is parallel. The thickness is the smaller of the two values.

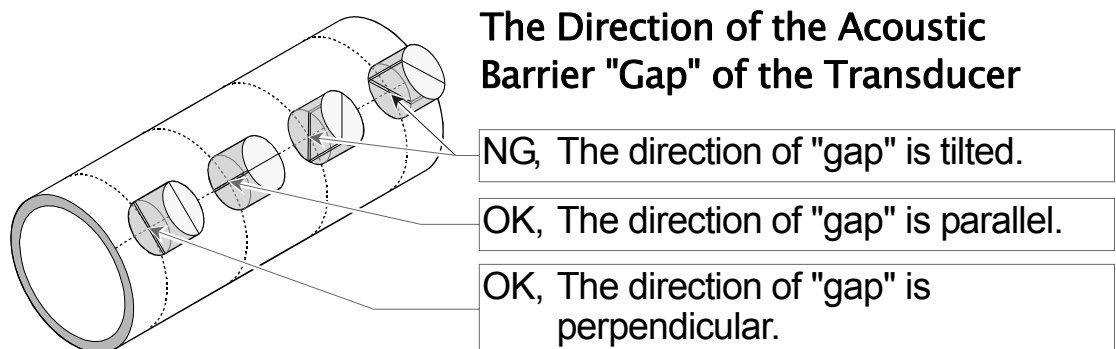

□ **Measuring Laminated Material**

In general, there is a difference in the density "sound velocity" between non-laminated and laminated materials "*taping, covering or painted with epoxy, polyethylene and adhesive, etc.*". Multi-laminated materials may even exhibit noticeable changes in the sound velocity across a single surface. In this case, it is necessary to perform a calibration procedure on a sample piece of known thickness. Ideally, the sample piece should be the same material being measured, or at least from the same lamination lot. Individual sound velocity errors can be minimized by doing so. When measuring laminates, an additional important consideration is that any included air gaps or pockets will cause premature reflection of the ultrasonic wave. If these effects exist, the thickness value would be less than the actual thickness. On the other hand, should air gaps or pockets exist in the material, their existence would be obvious as obtaining the correct measurement value will not be possible.

□ **Measurement through Paint and Coating**

The sound velocity is remarkably different when a coating exists. For example: A case that the surface of the steel pipe has a coating of approximately 0.6 [mm] thickness. The sound velocity of the steel pipe is 5920 [m/s]. The sound velocity of the coating is 2300 [m/s]. If the thickness is measured on the coated steel pipe after the sound velocity is set to the value of the steel pipe, the measured value would be 2.5 times that of the correct thickness. In this case, the error can be eliminated by the echo – echo mode. The echo – echo mode can measure the thickness by excluding the coating thickness completely.

- **Suitability of Materials**

The measurement of the thickness gage depends upon the sound wave passing through the material. All materials do not allow sound waves to penetrate. Ultrasonic thickness measurement can be used for metal, plastic, glass and multifarious materials. but it can not use for a part kind of cast iron, concrete, wood, fiberglass "fibre-reinforced plastic" or some rubber.

- **Reflection Wave**

In measuring of ultrasonic wave thickness in the standard pulse – echo mode, not the first reflected wave from the bottom face of the measured object but the second reflected wave may be measured. In this case, the thickness value is 2 times that of the correct thickness. Fully understand these phenomena when using this thickness gage.

5-4. Couplant

- **Function of the Couplant**

In order to couple the ultrasonic wave between the transducer and the material, it is necessary to fill the surface with couplant "Incompressible fluid." Typical couplants are machine oil, glycerin, water, and commercial couplant.

- **Suitable Quantity of the Couplant**

In general, apply approximately one drop of the couplant to the surface.

- **Error Related to the Couplant**

Should the couplant form a bridge-like thread when removing the transducer from the surface, the measurement value would be different between the value of placing the transducer on the surface and the value removing the transducer from the surface.

□ **Example of Couplants on the Market.**

Company name Magnaflux company

Registered trademark ULTRAGEL II[®], HIGH Z[®], SONO[®]

5-5. Measurement Principle

- When the ultrasonic wave is transmitted from the transmitter element of the transducer, the ultrasonic wave pulse "*T* pulse" is inputted into the material, and the ultrasonic wave pulse "Echo *B*" is reflected at the bottom, and is received at the receiver element which is then amplified as an electric signal. The ultrasonic thickness gage measures the time length between "*T* pulse" and "Echo *B*", and deducts a delay time of the delay material, and allows the thickness to be converted and displayed. The calculation formulas are as follows:

H : The thickness of the material

v : The sound velocity of the material

t : The time between inputting the ultrasonic wave and reflecting it at the bottom and receiving it as a echo.

$$H = \frac{v \times t}{2}$$

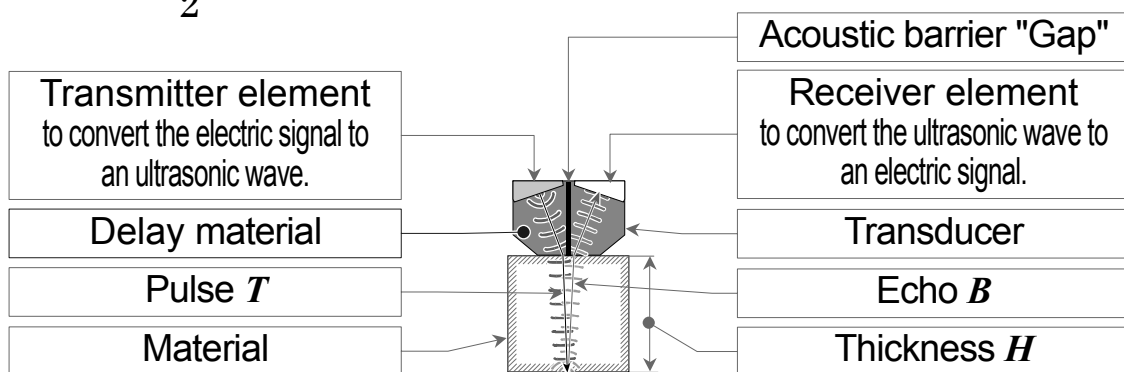

5-6. Reference Data of Sound Velocities

Caution The sound velocity of the substance varies in accordance with temperature and the characteristics of the substance.

Substance	Sound velocity [m/s]
Water 20 [°C]	1480
Natural rubber, Soft rubber	1550
Polyethylene	1900
Lead	2170
Vinyl chloride	2300
Epoxy resin	2500 to 2800
Acrylic resin	2720
Tin	3230
Gold	3240
Cast iron	3500 to 5600
Silver	3600
Zinc	4170
Brass	4700
Copper	4700
Quartz glass	5570
Nickel	5630
Teflon	5710
Crystal	5750
Stainless steel, SUS304	5790
Steel	5870 to 5950
Iron	5920
Titanium	5990
Aluminum	6260

6. Specifications

Measurements

Measurement method Ultrasonic pulse echo technique

Unit mm, m/s

Sampling rate

Single point mode 7 times/sec.

Scan mode 16 times/sec.

Measurement range

Pulse – echo mode

7 MHz transducer AD-3255-02 0.8 to 200.0 mm

5 MHz transducer AD-3255-03 1.0 to 300.0 mm

5 MHz transducer AD-3255-04 2.0 to 300.0 mm

Echo – echo mode

5 MHz transducer AD-3255-04 4.0 to 30.0 mm

Measurement accuracy

Range 0.8 to 50.0 mm ± 0.1 mm ± 0.5 %

50.1 to 300.0 mm ± 0.1 mm ± 1.5 %

The operation temperature range 5 to 40 °C

The range of the sound velocity 1000 to 9999 m/s

Display range 0.65 to 600.0 mm

Display resolution 0.1 / 0.01 mm

The accuracy depends upon the measurement conditions
and the surface of the material.

General

Display	4.5 digits LCD with EL backlight
Power source	2 alkaline batteries "LR6 or AA"
Operation environment	0 to 50 °C, less than 85 %R.H.
Storage environment	-10 to 55 °C, less than 85 %R.H.
Size of the main unit	73 mm(W) x 143 mm(H) x 32 mm(D)
Mass of the main unit	Approximately 160 g "excluding batteries"

Battery life

Approx. 30 hours or more with backlight off, 25 °C and measuring 4 mm thickness continuously

Battery indicator

The battery indicator blinks when the battery power has been consumed.

Automatic power off function

When left idle for approximately 5 minutes, the display blinks for 20 seconds and then the power is turned off.

Accessories

7 MHz transducer	1 piece
Test piece " <i>is equivalent to the thickness of 4.00 mm</i> "	1 piece
Carrying case	1 piece
Empty bottle for the couplant	1 piece
Strap	1 piece
Instruction manual " <i>This manual</i> "	1 book

Options and Accessories

AD-3255-01	Test piece " <i>is equivalent to the thickness of 4.00 mm</i> "	
AD-3255-02	7 MHz transducer, $\phi 6$ mm, Pulse - echo mode	0.8 to 200.0 mm
AD-3255-03	5 MHz transducer, $\phi 10$ mm, Pulse - echo mode	1.0 to 300.0 mm
AD-3255-04	5 MHz transducer, $\phi 10$ mm, Pulse - echo mode	2.0 to 300.0 mm
	Echo - echo mode	4.0 to 30.0 mm

List of the Transducer

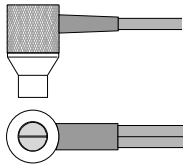
Type	AD-3255-02	Accessory
Display symbol	<i>P-07</i>	
Frequency	7 MHz	
Transducer element	φ6 mm	
Range	0.8 to 200.0 mm (Steel)	
Cable	Approximately 85 cm	
Use	Thin object, wall thickness of pipe, gradual curved surface, pulse – echo mode	
Minimum diameter	φ15 mm	
Wall thickness	x 2.0 mm	

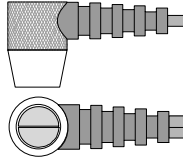
Type	AD-3255-03	Option
Display symbol	<i>P-05</i>	
Frequency	5 MHz	
Transducer element	φ10 mm	
Range	1.0 to 300.0 mm (Steel)	
Cable	Approximately 85 cm	
Use	Thick object, pulse – echo mode	
Minimum diameter	φ20 mm	
Wall thickness	x 3.0 mm	

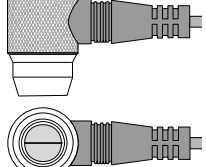
Type	AD-3255-04	Option
Display symbol	<i>P5EE</i>	
Frequency	5 MHz	
Transducer element	φ10 mm	
Range		
Pulse – echo mode	2.0 to 300.0 mm	
Echo – echo mode	4.0 to 30.0 mm	
Cable	Approximately 115 cm	
Use	Thick object	
Minimum diameter	φ20 mm	
Wall thickness	x 3.0 mm	

The following symbols are not used.

Display symbol	<i>P-02, H&S</i>
----------------------	----------------------



A&D Company, Limited

3-23-14 Higashi-Ikebukuro, Toshima-ku, Tokyo 170-0013, JAPAN
Telephone: [81] (3) 5391-6132 Fax: [81] (3) 5391-6148

A&D ENGINEERING, INC.

1756 Automation Parkway, San Jose, California 95131, U.S.A.
Telephone: [1] (408) 263-5333 Fax: [1] (408) 263-0119

A&D INSTRUMENTS LIMITED

Unit 24/26 Blacklands Way, Abingdon Business Park, Abingdon, Oxfordshire OX14 1DY United Kingdom
Telephone: [44] (1235) 550420 Fax: [44] (1235) 550485

A&D AUSTRALASIA PTY LTD

32 Dew Street, Thebarton, South Australia 5031, AUSTRALIA
Telephone: [61] (8) 8301-8100 Fax: [61] (8) 8352-7409

A&D KOREA Limited

한국에이.엔.디(주)

서울특별시 영등포구 국제금융로6길33 (여의도동) 맨하탄빌딩 817 우편 번호 150-749
(817, Manhattan Bldg., 33. Gukjegeumyung-ro 6-gil, Yeongdeungpo-gu, Seoul, 150-749 Korea)
전화: [82] (2) 780-4101 팩스: [82] (2) 782-4280

ООО A&D RUS

ООО "Эй энд Ди Рус"

121357, Российская Федерация, г.Москва, ул. Верейская, дом 17
(Business-Center "Vereyskaya Plaza-2" 121357, Russian Federation, Moscow, Vereyskaya Street 17)
тел.: [7] (495) 937-33-44 факс: [7] (495) 937-55-66

A&D INSTRUMENTS INDIA PRIVATE LIMITED

ऐ&डी इन्स्ट्र्यूमेन्ट्स इण्डिया प्रा० लिमिटेड

509, उद्योग विहार , फेस -5, गुडगांव - 122016, हरियाणा , भारत
(509, Udyog Vihar, Phase-V, Gurgaon - 122 016, Haryana, India)
फोन : 91-124-4715555 फैक्स : 91-124-4715599