

Table of Contents

1. Important Safety Information	5
1.1 Safety and Property Damage Warnings	5
OVERLOAD HAZARD	6
FAULTY TIGHTENING TORQUE HAZARD	6
RISK OF EXPLOSION AND FIRE	6
PERMISSIBLE ENVIRONMENTAL CONDITIONS	7
1.2 Personal Protective Gear	7
1.3 Proper Use	7
1.4 Handling	8
1.5 Work Environment	8
2. Product Description	9
3. Using the Torque Wrench	10
3.1 Right tightening and left tightening	10
3.2 Setting the Torque	11
3.3 Working with Tool Accessories	12
3.4 Tightening Screws	13
3.5 Use with rotation angle measurement equipment	16
4. Maintenance	17
4.1 Testing and Calibrating	17
4.2 Care and Storage	19
5. Accessories and Parts	19
6. Environmentally Friendly Disposal	19
7. Technical Data	20
7.1 Technical Data, TORCOFIX K	20
7.2 Technical Data, TORCOFLEX UK	21

1. Important Safety Information



Read and understand this manual before using the torque wrench. Incorrect use can cause **SERIOUS INJURY** or **DEATH**.

This manual is part of the torque wrench. It must be kept in a safe place for later use and be passed along with the torque wrench if it is sold, loaned, or otherwise transferred.



The torque wrench should only be used by **TRAINED USERS** who have been instructed in the safe handling of the tool. Operation without training can cause **SERIOUS INJURY** or **DEATH**.

Ensure that these Operating Instructions have been read and understood prior to the initial use of the torque wrench. The Operating Instructions **MUST** be available to the user at all times.

1.1 Safety and Property Damage Warnings

Throughout this manual **WARNING**, **CAUTION**, **NOTICE**, and the **SAFETY ALERT SYMBOL** will be used.

WARNING

Indicates a hazardous situation which, if not prevented, could result in death or serious injury.

CAUTION

Indicates a hazardous situation which, if not prevented, can result in minor or moderate injury.

NOTICE

Indicates a hazardous situation which, if not prevented, can result in property damage or in damage to the torque wrench.



This is the safety alert symbol. It is used to alert you to potential personal injury hazards. Obey all safety messages that follow this symbol to avoid possible injury or death. Note that this symbol is incorporated into the warning and caution indicators above.

⚠WARNING**OVERLOAD HAZARD**

The torque wrench can be overloaded during use and break as a result. This might cause **SERIOUS INJURY** or **DEATH**.

Always use original accessory parts **ONLY**. When using accessory parts not approved by the manufacturer there is also the risk that they will not bear the loads.

Check the torque wrench for damage prior to **EVERY** application.

NEVER use the torque wrench if it has been dropped, has struck against other objects or objects have fallen on the torque wrench.

⚠WARNING**FAULTY TIGHTENING TORQUE HAZARD**

An uncalibrated torque wrench can cause screw connections, the torque wrench and accessories to fail and produce faulty screw connections. This might cause **SERIOUS INJURY** or **DEATH**.

Always use tested and calibrated torque wrenches **ONLY**, see section 4.1. Always use tested torque testing equipment **ONLY**.

⚠WARNING**RISK OF EXPLOSION AND FIRE**

Sparks can occur when using the torque wrench, which can cause an explosion or a fire and might cause **SERIOUS INJURY** or **DEATH**.

NEVER use the torque wrench in areas where sparks can cause explosions or fires.

WARNING**PERMISSIBLE ENVIRONMENTAL CONDITIONS**

If the torque wrench is exposed to temperatures under 18°C or above 28°C or atmospheric humidity higher than 90%, faulty tightening torque can be the result.

ALWAYS check the torque wrench with an approved torque tester before use in extreme climatic conditions.

1.2 Personal Protective Gear

ALWAYS wear personal protective gear when using the torque wrench. The torque wrench can slip or break. This might cause **SERIOUS INJURY** or **DEATH**.



ALWAYS wear **EYE PROTECTION** (ANSI/ISEA Z87.1-2010) designed to protect you from flying objects when using the torque wrench.

- **PARTICLES** may be hurled upward during work with the torque wrench. This might cause **SERIOUS INJURY** or **DEATH**.



ALWAYS wear **SAFETY GLOVES** when using the torque wrench.

- The torque wrench can slip or break. This can cause **SERIOUS INJURY** to fingers and hands.



ALWAYS wear **SAFETY SHOES** with slip-resistant soles and steel toe caps (ASTM F2413-05) when using the torque wrench.

- Falling parts can cause **SERIOUS INJURY** to feet and toes.

1.3 Proper Use

The torque wrench is designed for controlled torque tightening.

- Use the torque wrench for this application **ONLY**.
- Any other use might cause **SERIOUS INJURY** or **DEATH**.
- **NEVER** allow children to use the torque wrench.

1.4 Handling

⚠ WARNING

NEVER use tool accessories with a torque wrench with a built-in ratchet.

Take the following safety precautions to prevent injuries and damage caused by improper handling and unsafe use of the torque wrench.



Unsafe use can cause **SERIOUS INJURY** or **DEATH**.

- **NEVER** use the torque wrench for loosening screw connections.
- **NEVER** use a damaged torque wrench.
- **NEVER** use a torque wrench and accessory parts that have been modified.
- **NEVER** modify a torque wrench and accessory parts.
- **ALWAYS** check the torque wrench, particularly the square and the housing, as well as the accessory parts, for visible damage prior to use.
- **ALWAYS** release the torque wrench **IMMEDIATELY** on the sound of a click.
- **ALWAYS** apply the torque wrench in the direction of rotation specified. Follow the direction of rotation arrow.
- **ALWAYS** use standard accessory parts or parts approved by the manufacturer.
- After use, at the end of the workday at the latest, **ALWAYS** reset the torque wrench to the lowest setting.
- **ALWAYS** hold the torque wrench at the center of the handle.
- **ALWAYS** transport the torque wrench in the shockproof packaging material.

1.5 Work Environment



ALWAYS use the torque wrench in a safe work environment.

- Keep the work space clean and tidy.
- The work space must be sufficiently large and secured.
- The work space must be free of high dust concentration.

2. Product Description

- 1: locking button
- 2: Handle
- 3: Scale
- 4: Scale ring
- 5: Housing tube
- 6: Drive lever
- 7: Drive

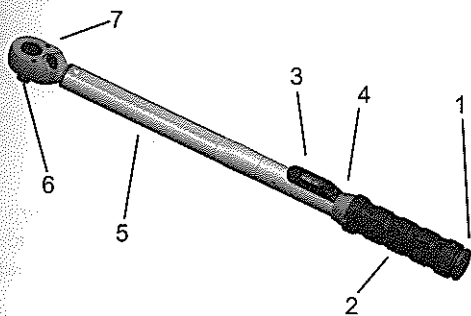
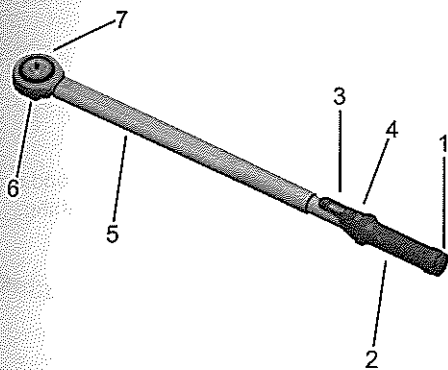
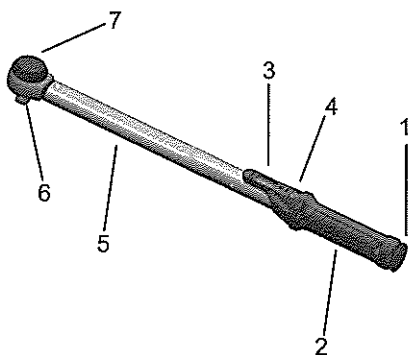

3. Using the Torque Wrench



ALWAYS read the important Safety Information (section 1) BEFORE using the torque wrench.

The instructions describe the use of the following product types:

- Torque wrench with ratchet and mushroom head or with square drive as of $\frac{3}{4}$ " and
- Torque wrench with reversible ratchet

ALWAYS apply the torque wrench in the direction of rotation specified. Follow the direction of rotation arrow.

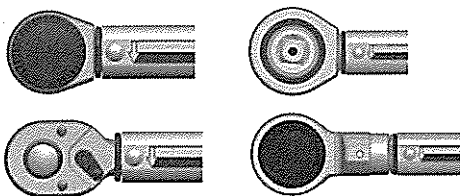

3.1 Right tightening and left tightening

- Torque wrench with ratchet and mushroom head or with square drive as of $\frac{3}{4}$ " with right and left tightening.



- Torque wrench with reversible ratchet for controlled right tightening.



The screw tightening process is shown in diagram form with a torque wrench fitted with a ratchet and mushroom head. The processes for screw tightening do not differ between ratchet with mushroom head and changeover ratchet. The relevant direction of rotation is marked and can clearly be seen on the housing.

3.2 Setting the Torque

⚠WARNING

ALWAYS make sure that you use the scale with the requisite unit. Non-compliance of the requisite scale can result in faulty screw connections. These might cause damage, **SERIOUS INJURY** or **DEATH**.

Familiarize yourself with the torque wrench and its scales. Some torque wrenches are equipped with a double scale (N·m / lbf·ft or lbf·in). Check the unit and scale for K-Model.

The desired torque ALWAYS has to be set before using the torque wrench.

Pull out the locking button (1) on the end of the handle (2).

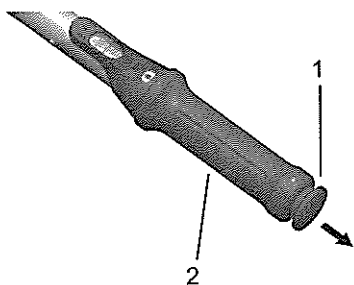

Turn the handle (2) until the desired torque in the particular scale (3) N·m or lbf·ft / lbf·in is identical with the mark in the reading glass.

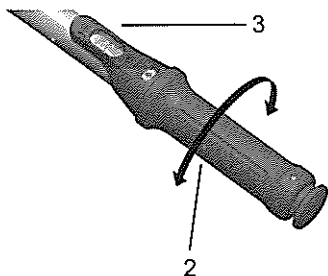

Note:

Model UK only N·m

Make a precise adjustment of the main scale with the scale ring (4).

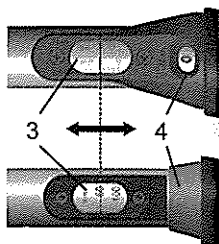

Push the locking button (1) back into the end of the handle (2). Attention should be paid to ensure that the locking button (1) engages properly. Only then is the torque safely set.

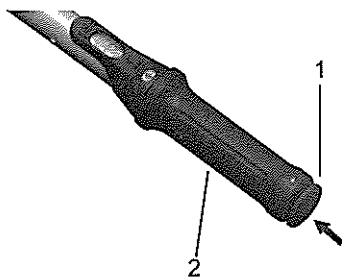

To change the direction of rotation for the $\frac{3}{4}$ " with square drive, push the trigger pin with your thumb and push the square drive through, rotate the torque wrench and replace the square drive.

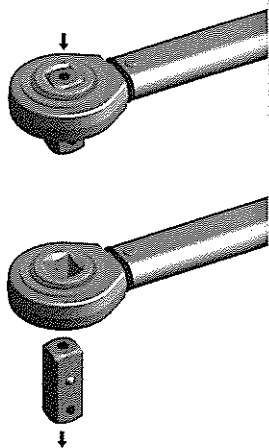

3.3 Working with Tool Accessories

⚠WARNING

NEVER use tool accessories with a torque wrench with a built-in ratchet.

3.4 Tightening Screws

⚠WARNING**OVERLOAD HAZARD**

The torque wrench can be overloaded during use and break as a result. This might cause **SERIOUS INJURY** or **DEATH**.

Always use original accessory parts **ONLY**. When using accessory parts not approved by the manufacturer there is also the risk that they will not bear the loads.

Check the torque wrench for damage prior to **EVERY** application.

NEVER use the torque wrench if it has been dropped, has struck against other objects or objects have fallen on the torque wrench.

ALWAYS release the torque wrench **IMMEDIATELY** on the sound of a click.

⚠WARNING**FAULTY TIGHTENING TORQUE HAZARD**

An uncalibrated torque wrench can cause screw connections, the torque wrench and accessories to fail and produce faulty screw connections. This might cause **SERIOUS INJURY** or **DEATH**.

Always use tested and calibrated torque wrenches **ONLY**, see section 4.1. Always use tested torque testing equipment **ONLY**.

Safety Information:

Take the following safety information into account when using the torque wrench in order to prevent accidents and damage.

- ALWAYS use original accessory parts approved by the manufacturer.
- ALWAYS check the torque wrench for the proper torque setting.
- ALWAYS position the torque wrench and socket extensions at a 90° angle.
- When using socket extensions, e.g. for deep seated screw positions, ALWAYS select the shortest possible extension.
- If the resistance changes unexpectedly while tightening a screw connection, IMMEDIATELY release the torque wrench. Check the torque wrench and the screw connection for damage.
- NEVER use reducers. The square on the torque wrench is designed for the forces intended. Reducers will not bear the load.
- ALWAYS apply the torque wrench in the direction of rotation specified. Follow the direction of rotation arrow.
- ALWAYS hold the torque wrench at the center of the handle.

Tightening screws:

- 1) ALWAYS check the screw connection for damage or wear.
- 2) ALWAYS determine the screw connection's width before tightening the screw.
- 3) ALWAYS select the appropriate accessory part.
- 4) Fit this accessory to the holder of the torque wrench.

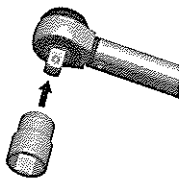
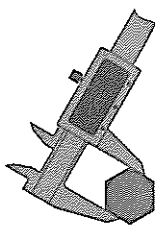

- 5) Take care that the catching elements latch when putting the accessory part on the torque wrench's adaptor. Check for a secure connection by lightly pulling on the accessory part.

- 6) Put the torque wrench on the screw at a 90° angle.

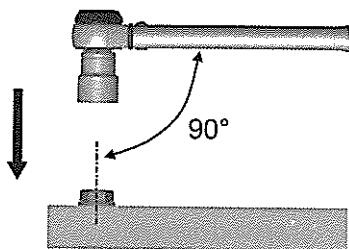

- 7) Turn the torque wrench by the handle slowly and steadily in the direction of the arrow (follow the direction of rotation arrow) until a click sound can be heard and a slight jerk felt.

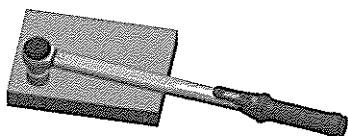
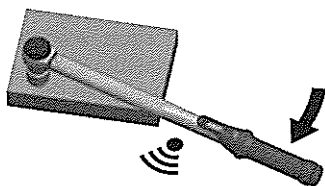
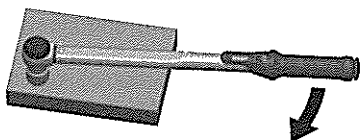

- !** ALWAYS release the torque wrench IMMEDIATELY on the sound of a click.

The torque wrench is immediately operational again.

3.5 Use with rotation angle measurement equipment

Set the torque wrench to the "snug torque" required. Select the appropriate rotation angle measurement instrument (adaptor). Simply insert the rotation angle measurement instrument between the torque wrench's square drive and the application tool's adaptor square.

Attach the rotation angle measurement instrument in the manner described in your rotation angle measurement instrument operating manual.

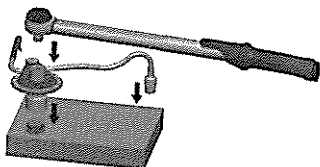

Turn the torque wrench by the handle (2) slowly and steadily in the direction of the arrow (follow the direction of rotation arrow) until a click sound can be heard and a slight jerk felt.

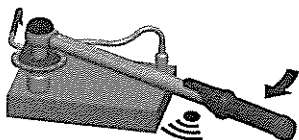

Now set the torque wrench to its max. permissible torque. Set the degree disk to the desired angle.

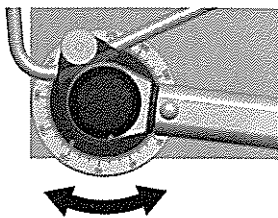

Turn the torque wrench by the handle slowly and steadily in the direction of the arrow until the rotation angle measurement instrument arrow points to "0". If a click sound is heard and a slight jerk felt, IMMEDIATELY release the torque wrench.

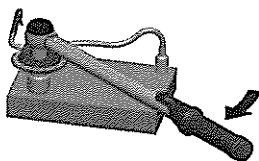

The screwing cannot be completed with the torque wrench being used because the torque wrench's max. torque is exceeded.



ALWAYS see to it that you do not exceed the torque wrench's maximum load capacity, including the values obtained by angle tightening.

4. Maintenance

4.1 Testing and Calibrating

⚠WARNING

FAULTY TIGHTENING TORQUE HAZARD

An uncalibrated torque wrench can cause screw connections, the torque wrench and accessories to fail and produce faulty screw connections. This might cause **SERIOUS INJURY** or **DEATH**.

Always use tested and calibrated torque wrenches **ONLY**.
Always use tested torque testing equipment **ONLY**.

Powerful forces are at work when using the torque wrench. When torque wrenches are not tested or not serviced there is a risk that they will not bear the loads or will indicate faulty tightening torques. **ALWAYS** take the following safety information into account in order to prevent **SERIOUS INJURY** or **DEATH**:

- **ALWAYS** test the accuracy of the torque wrench with an approved torque tester before use.
- **NEVER** use a faulty torque wrench.
- **ALWAYS** have the torque wrench calibrated on a regular basis.

According to DIN EN ISO 6789 the minimum calibration interval requirement for a torque wrench is one year or 5000 load cycles (whichever case occurs first). A firm's own specifications or quality requirements for screwing applications can also lead to considerably shorter calibration intervals.

NOTICE

NEVER neglect recalibrating the torque wrench. Improper calibration can cause the torque wrench to be damaged.

Calibration should ONLY be implemented by authorized specialists, an accredited calibration laboratory or the manufacturer.

A calibration certificate as per DIN EN ISO 6789 comes with every new torque wrench. The torque wrench and the calibration certificate are labeled with the identical serial number.

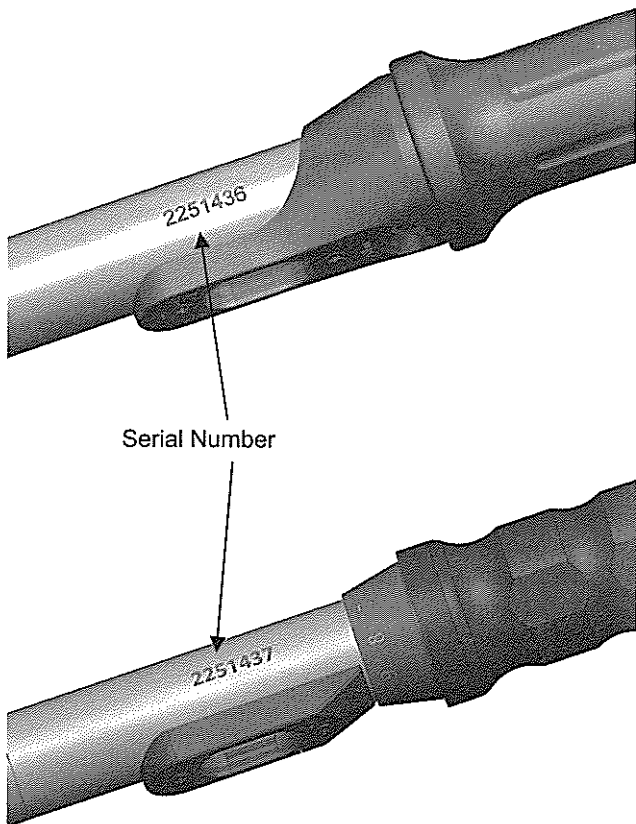

4.2 Care and Storage

NOTICE

The torque wrench can be damaged due to improper handling. ALWAYS take the following precautions to prevent damage:

- NEVER use cleansing agents to clean the torque wrench. They can cause the mechanism's permanent lubrication to be degraded.
- Clean all parts after every use ONLY with a clean cleaning cloth.
- NEVER immerse the torque wrench in water.
- After use, at the end of the workday at the latest, ALWAYS reset the torque wrench to the lowest setting.
- After use put the torque wrench back in the packing material to protect against corrosion.
- Store the torque wrench in the packing material in a clean and dry location.

5. Accessories and Parts

The manufacturer provides a variety of components in the accessory parts program, which open up other areas of application and make work even more effective and more efficient.

6. Environmentally Friendly Disposal

Dispose of the torque wrench, accessory parts and packaging material in accordance with applicable provisions of law.

7. Technical Data

The following data are for orientation purposes. Due to the ongoing further development of the product, deviations can result.

7.1 Technical Data, TORCOFIX K

Technical Data Torcofix K															
Code-Nr.	Type	DIN 3120		Inch		N·m		Operating range lbf·in		lbf·ft		Graduation scale		Graduation scale ring	
		A 6.3	A 10	1/4"	3/8"	1	5	from	to	from	to	N·m	in	N·m	in
2201429	4549-00	A 6.3	A 10	1/4"	3/8"	1	5	0.75	3.7	0.75	3.7	0.25	1.0	0.025	-
1545140	4549-05	A 10	A 12.5	3/8"	1/2"	10	50	7.5	37	7.5	37	2.5	10	0.25	-
7601610	4550-20	A 12.5	A 15	1/2"	3/4"	40	200	30	150	30	150	10	40	1	-
7674330	4550-40	B 20	B 25	3/4"	1"	60	400	60	300	60	300	10	40	1	-
1521365	4550-75	B 20	B 25	3/4"	1"	150	750	110	650	110	650	10	40	1	-
Code-Nr.	Type	mm		in		mm		in		mm		in		Weight (without packaging)	
		mm	in	mm	in	mm	in	mm	in	mm	in	mm	in	kg	lb
2201429	4549-00	145.0	5.75	35	1.38	25.3	1.00	25.0	1.02	224.0	8.82	224.0	8.82	0.32	0.71
1545140	4549-05	256.5	10.10	35	1.38	25.3	1.00	26.0	1.02	334.5	13.17	334.5	13.17	0.48	1.05
7601610	4550-20	394.2	15.52	44	1.73	35.9	1.41	35.0	1.38	485.5	19.11	485.5	19.11	1.13	2.49
7674330	4550-40	583.2	22.95	67	2.64	67	2.64	46.0	1.81	655.0	27.01	655.0	27.01	1.86	4.09
1521365	4550-75	1126.7	44.44	69	2.72	327.0	12.87	327.0	12.87	1232.5	48.52	1232.5	48.52	4.50	9.89

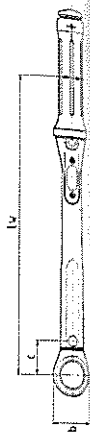
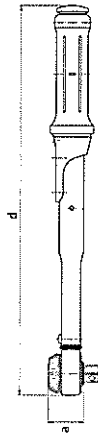

7.2 Technical Data, TORCOFLEX UK

Technical Data Torcoflex UK

Code-Nr.	Type	□		N·m		Operating range lbf·in		lbf·ft		Graduation scale		Graduation scale ring	
		DIN 3120	Inch	from	to	from	to	from	to	N·m	In	N·m	In
2958007	3549-00	A 6.3	1/4"	1	5	-	-	-	-	0.25	-	0.025	-
2958008	3549-02	A 10	3/8"	5	25	-	-	-	-	0.5	-	0.1	-
2958023	3549-05	A 10	3/8"	10	50	-	-	-	-	2.5	-	0.25	-
2958031	3550-10	A 12.5	1/2"	20	100	-	-	-	-	5	-	0.5	-
2958059	3550-20	A 12.5	1/2"	40	200	-	-	-	-	10	-	1	-
2958068	3550-30	A 12.5	1/2"	60	300	-	-	-	-	10	-	1	-
* 2958074	3550-40	B 20	3/4"	80	400	-	-	-	-	10	-	1	-
* 2958082	3550-55	B 20	3/4"	110	550	-	-	-	-	10	-	1	-
Code-Nr.	Type	lw		a		b		c		d		Weight (without packaging)	
		mm	In	mm	In	mm	In	mm	In	mm	In	kg	lb
2958007	3549-00	152.0	5.98	15	0.59	25	0.98	32.0	1.26	225.0	8.86	0.32	0.70
2958015	3549-02	212.0	8.35	15	0.59	25	0.98	32.0	1.26	235.5	9.34	0.41	0.90
2958023	3549-05	270.5	10.65	18	0.71	35	1.38	40.0	1.57	348.5	13.72	0.48	1.06
2958031	3550-10	318.2	12.53	27	1.07	40.5	1.67	50.0	1.97	408.5	16.09	0.73	1.61
2958059	3550-20	409.2	16.11	22	0.87	42.5	1.67	50.0	1.97	493.8	19.68	1.16	2.55
2958068	3550-30	509.9	19.70	22	0.87	42.5	1.67	50.0	1.97	553.8	21.65	1.36	2.99
* 2958074	3550-40	633.9	24.96	36	1.42	68	2.68	97.0	3.82	737.5	29.04	2.10	4.62
* 2958082	3550-55	834.5	32.82	36	1.42	86	3.38	93.0	3.66	968.0	38.23	3.10	6.84

