

# CAMERA ASSISTED RETRIEVAL TOOL (CART™)

MODEL: E-CART-1

Information: [Ullman-Devices.com](http://Ullman-Devices.com)  
 Contact: (203) 438-6577  
[info@ullman-devices.com](mailto:info@ullman-devices.com)

ULLMAN™

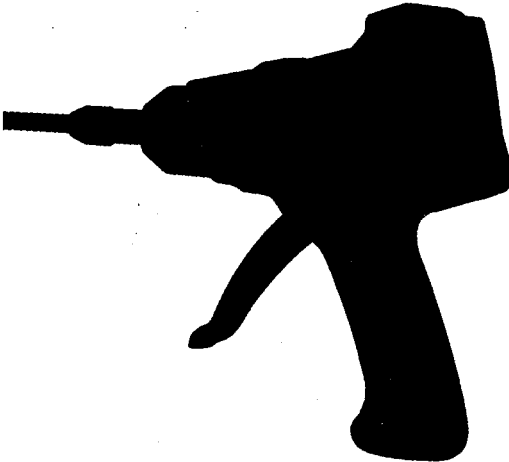

**WARNING:** Read and understand this guide prior to use. Failure to follow operating instructions could result in permanent damage of the machine.

## Button Functionality

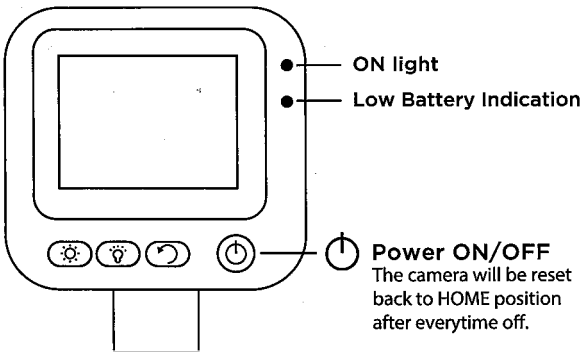

## Claw Components

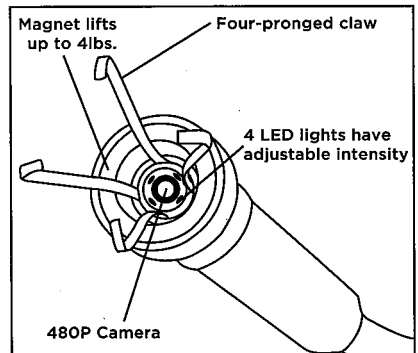

**Screen Brightness:** LCD display screen brightness can be adjusted to compensate for ambient light.



**LED Intensity:** The intensity of the lights can be adjusted to 6 different intensity levels.



**Image Orientation:** Button flips camera 180° and mirror images of both views.

i.e.: F    ƒ

ƒ    F

# BEFORE FIRST TIME USE



1. Carefully remove the CART from the packaging.

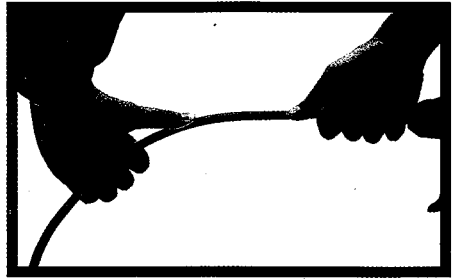

2. Straighten the arm before squeezing claw trigger for the first time.

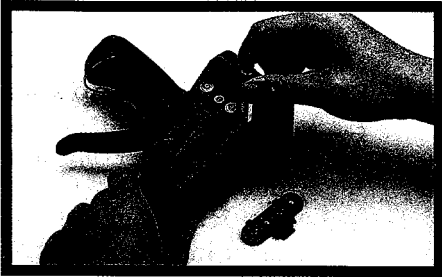

3. Properly install the 4xAA batteries into the battery compartment. Be sure to remove if storing for long periods of time.



4. Hold the power button for 3 seconds to turn the unit off and on.



5. Be sure to adjust the LCD screen and LED brightness to optimize viewing of target object.

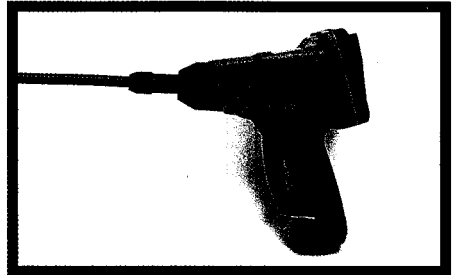

6. To hold the claws out of the camera view when searching for an object, use the handle clip to hold the trigger until the claw is needed.

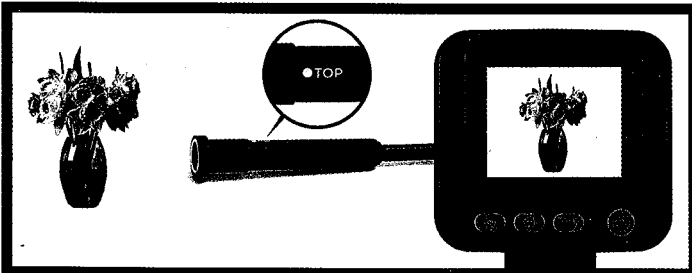

7. To ensure the camera shows an accurate angle on the home screen after bending, adjust the arm by lightly twisting it until the TOP mark is aligned to the top of the CART body.

# IMPORTANT

1. DO NOT pull the trigger when the CART is in its packaging.

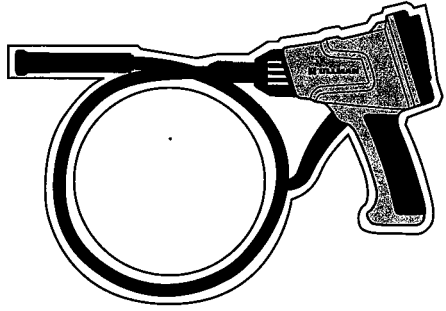

2. When bending, always keep the radius more than 7 in., or the claw may not function properly. NEVER bend the arm past 90 degrees, or the claw may not function properly.

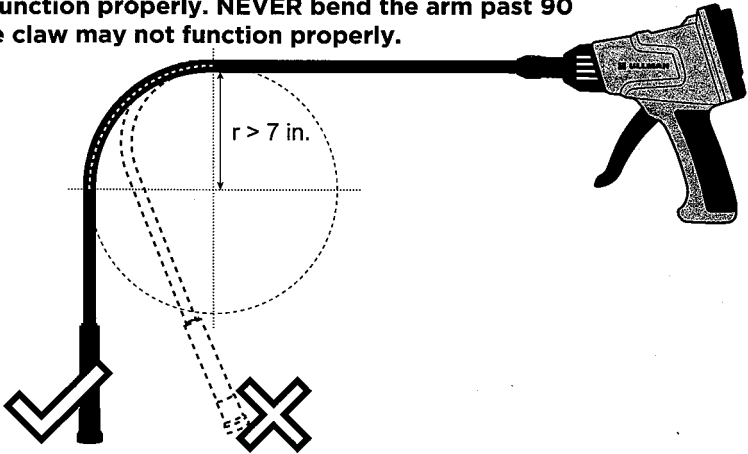

3. DO NOT bend the arm immediately next to the body or CART head.

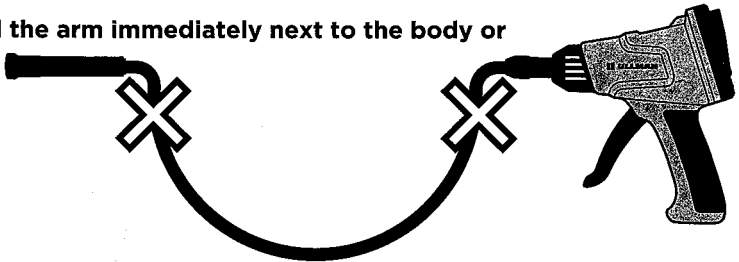

4. DO NOT squeeze the trigger if CART head is pressed against a solid surface, or claw may be damaged.

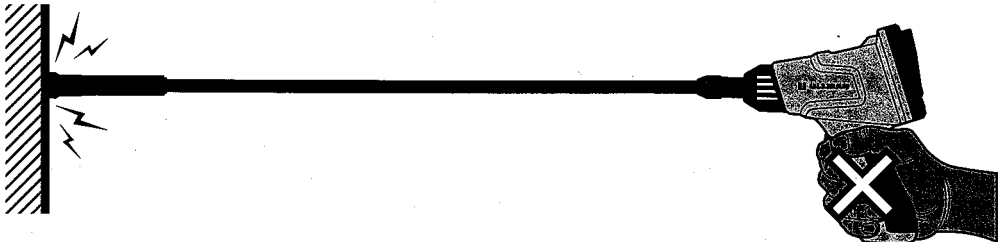

5. While the Camera Assisted Retrieval Tool head is water resistant, it is highly recommended that it is submerged only infrequently. Caution must be exercised that the main unit does not encounter any moisture. If submerged, the CART must immediately be stored in a position that allows all remaining moisture to exit out of the tool.

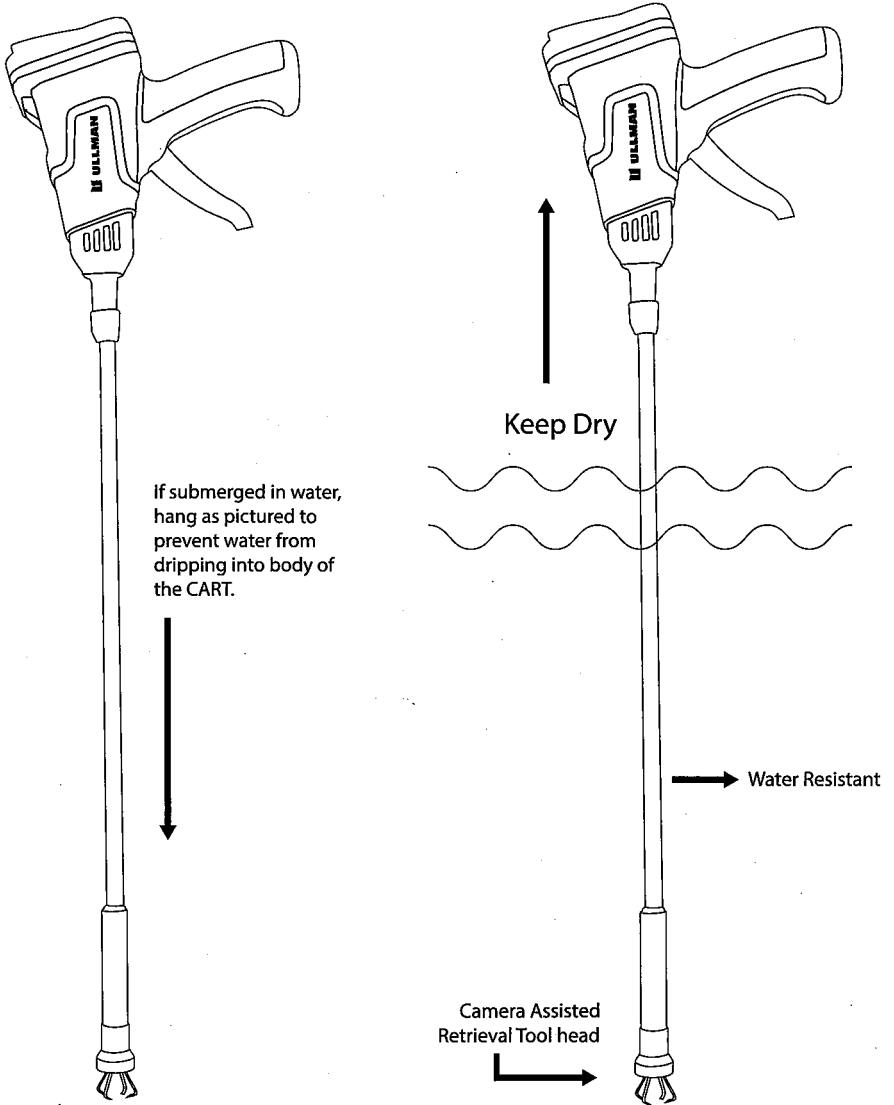

**CAUTION: PINCH POINT**

### Warranty

The CART is warranted against manufacturer defect for 1 year from date of purchase. Please go to [Ullman-devices.com](http://Ullman-devices.com) for warranty information. Please save your receipt as it will be required to prove date of purchase.