

Product Data Sheet



B-VW 125R

EAN 4047526561772

ID 561779

Pressed steel fixed castor, medium duty brackets, with top plate fitting, Wheels with 'Blickle Soft' soft rubber tyres, with pressed steel rim

Bracket:

Made of pressed steel. Bolted wheel axle. Zinc-plated, blue-passivated, Cr6-free.

Wheels:

Made of 'Blickle Soft' highly elastic soft rubber, round profile, highest operational comfort, exceptionally low-noise operation, excellent floor preservation.

Tread/tyre: Made of "Blickle Soft" soft rubber.

Tread colours black

Wheel centre/rim:

Pressed steel rim with tubular steel hub, pressed rim (special shock and impact-resistant design), zinc-plated, blue-passivated, Cr6-free. Tyre pressed with rim.

Wheel centre colour: blue passivated



Rolling resistance

■ ■ ■ □ □ Good

Operating noise

■ ■ ■ ■ ■ Excellent











Floor surface preservation

■ ■ ■ ■ ■ Excellent

Product Data Sheet



Technical data

| | | |
|---------------------------|--|----------------|
| Plate size |  | 100 x 85 |
| Bolt hole spacing |  | 80 x 60 |
| Bolt hole Ø |  | 9 |
| Wheel Ø |  | 125 mm (D) |
| Wheel width |  | 37,5 mm (T2) |
| Load capacity |  | 50 kg |
| Total height |  | 150 mm (H) |
| unit weight |  | 1 kg |
| Temperature resistance |  | -25 ° C |
| Temperature resistance to |  | 80 ° C |
| tread and tyre hardness | | 50° Shore A |
| Bearing type: |  | Roller bearing |

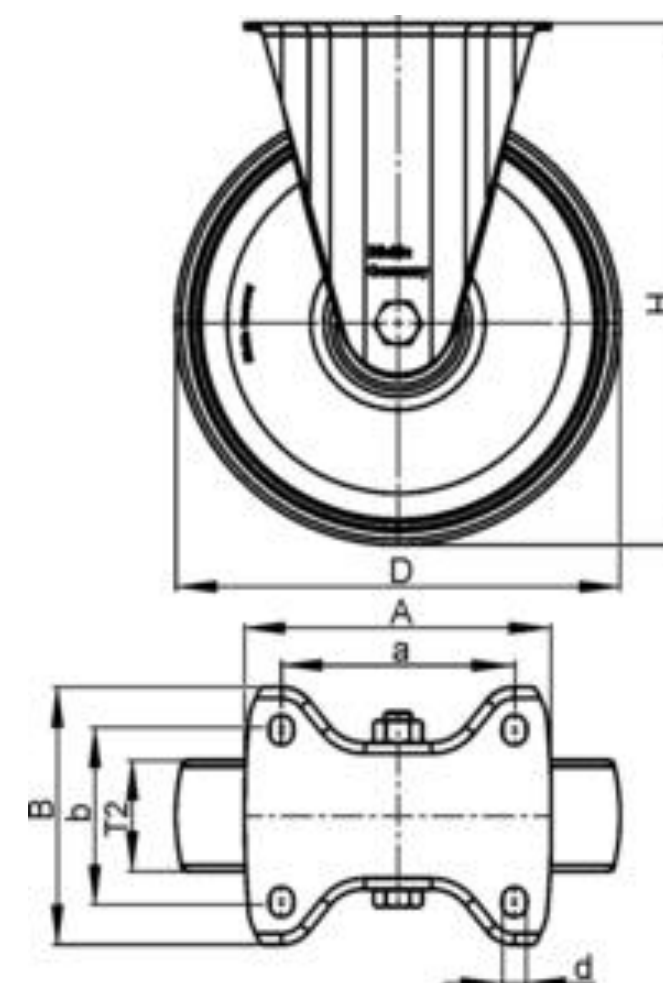

Product Data Sheet



Variants



B-VW 125R-FA

Pressed steel fixed castor, medium duty brackets, with top plate fitting, Wheels with 'Blickle Soft' soft rubber tyres, with pressed steel rim



B-VW 125R-SG

Pressed steel fixed castor, medium duty brackets, with top plate fitting, Wheels with 'Blickle Soft' soft rubber tyres, with pressed steel rim



B-VW 125R-SG-FA

Pressed steel fixed castor, medium duty brackets, with top plate fitting, Wheels with 'Blickle Soft' soft rubber tyres, with pressed steel rim