

Product Data Sheet



L-VW 162R

EAN 4047526539764

ID 539767

Pressed steel swivel castor, medium heavy duty brackets, with top plate fitting, Wheels with 'Blickle Soft' soft rubber tyres, with pressed steel rim

Bracket:

Made of heavy pressed steel, with double ball bearing in the swivel head, strong central kingpin, swivel head seals. The special Blickle dynamic riveting process of the swivel head results in minimal swivel head play and smooth rolling characteristics with an increased service life achieved by the work hardening of the ball race grooves. Bolted wheel axle. Zinc-plated, blue-passivated, Cr6-free.

Wheels:

Made of 'Blickle Soft' highly elastic soft rubber, round profile, highest operational comfort, exceptionally low-noise operation, excellent floor preservation.

Tread/tyre: Made of "Blickle Soft" soft rubber.

Tread colours: black

Wheel centre/rim:

Pressed steel rim with tubular steel hub, pressed rim (special shock and impact-resistant design), zinc-plated, blue-passivated, Cr6-free. Tyre pressed with rim.

Wheel centre colour: blue passivated



Rolling resistance

■ ■ ■ □ □ Good

Operating noise

■ ■ ■ ■ ■ Excellent













Floor surface preservation

■ ■ ■ ■ ■ Excellent

Product Data Sheet



Technical data

Plate size		140 x 110
Bolt hole spacing		105 x 75-80
Bolt hole Ø		11
Wheel Ø		160 mm (D)
Tyre width		40 mm (T2)
Load capacity		70 kg
Total height		195 mm (H)
Offset swivel castor		60 mm
unit weight		2,6 kg
Temperature resistance		-25 ° C
Temperature resistance to		80 ° C
tread and tyre hardness		50° Shore A
Bearing type:		Roller bearing

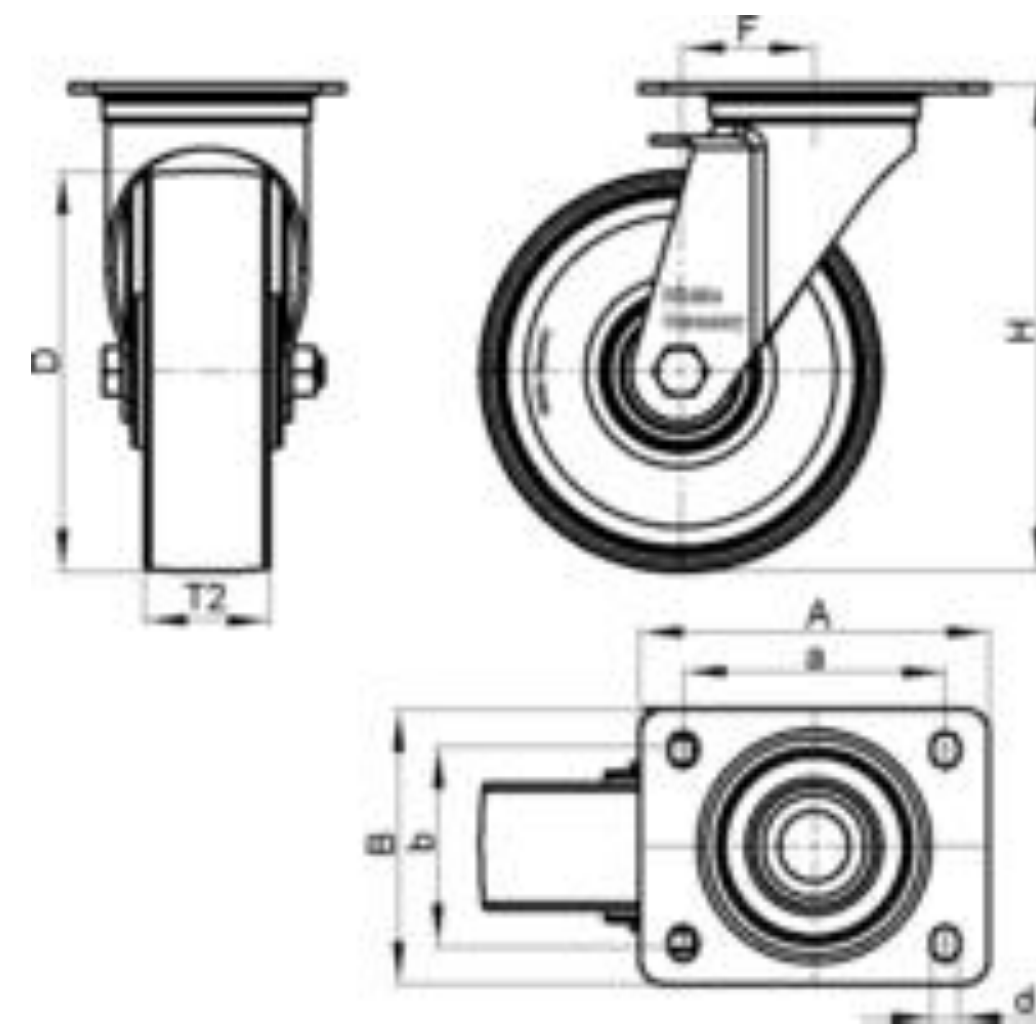

Product Data Sheet



Variants



L-VW 162R-FA

Pressed steel swivel castor, medium heavy duty brackets, with top plate fitting, Wheels with 'Blickle Soft' soft rubber tyres, with pressed steel rim



L-VW 162R-FI

Pressed steel swivel castor, medium heavy duty brackets, with top plate fitting and 'stop-fix' brake, Wheels with 'Blickle Soft' soft rubber tyres, with pressed steel rim



L-VW 162R-FI-FA

Pressed steel swivel castor, medium heavy duty brackets, with top plate fitting and 'stop-fix' brake, Wheels with 'Blickle Soft' soft rubber tyres, with pressed steel rim



L-VW 162R-FI-SG

Pressed steel swivel castor, medium heavy duty brackets, with top plate fitting and 'stop-fix' brake, Wheels with 'Blickle Soft' soft rubber tyres, with pressed steel rim



L-VW 162R-FI-SG-FA

Pressed steel swivel castor, medium heavy duty brackets, with top plate fitting and 'stop-fix' brake, Wheels with 'Blickle Soft' soft rubber tyres, with pressed steel rim



L-VW 162R-SG

Pressed steel swivel castor, medium heavy duty brackets, with top plate fitting, Wheels with 'Blickle Soft' soft rubber tyres, with pressed steel rim



L-VW 162R-SG-FA

Pressed steel swivel castor, medium heavy duty brackets, with top plate fitting, Wheels with 'Blickle Soft' soft rubber tyres, with pressed steel rim



L-VW 162R-ST

Pressed steel swivel castor, medium heavy duty brackets, with top plate fitting and 'stop-top' brake, Wheels with 'Blickle Soft' soft rubber tyres, with pressed steel rim



L-VW 162R-ST-FA

Pressed steel swivel castor, medium heavy duty brackets, with top plate fitting and 'stop-top' brake, Wheels with 'Blickle Soft' soft rubber tyres, with pressed steel rim



L-VW 162R-ST-SG

Pressed steel swivel castor, medium heavy duty brackets, with top plate fitting and 'stop-top' brake, Wheels with 'Blickle Soft' soft rubber tyres, with pressed steel rim

Product Data Sheet



Variants



L-VW 162R-ST-SG-FA

Pressed steel swivel castor, medium heavy duty brackets, with top plate fitting and 'stop-top' brake, Wheels with 'Blickle Soft' soft rubber tyres, with pressed steel rim

Option:



RI-05.03

Directional lock