

Product Data Sheet



LI-VEHI 200R

EAN 4047526609429

ID 609420

Heat-resistant pressed steel swivel castor with top plate fitting, Heat-resistant Blickle TempLine® Basic wheel with solid rubber tyres, with pressed steel rim

Bracket:

Made of pressed steel, with double ball bearing in the swivel head, strong central kingpin, ball protection by the special top plate design. The special Blickle dynamic riveting process of the swivel head results in smooth rolling characteristics, increased service life and the swivel head play is set specifically for high temperature applications, with special heat-resistant grease. Bolted wheel axle. Zinc-plated, blue-passivated, Cr6-free.

Wheels:

Made of standard solid rubber, very high operational comfort, low-noise operation, very good floor preservation, PAH conform acc. to EU directive 2005/69/EC.

Tread/tyre: Made of heat-resistant solid rubber.

Tread colours black

Wheel centre/rim:

Pressed steel rim, zinc-plated, blue-passivated, Cr6-free.

Wheel centre colour: blue passivated



Rolling resistance

■ ■ □ □ □ Satisfactory

Operating noise

■ ■ ■ ■ □ Very good









Floor surface preservation

■ ■ ■ ■ □ Very good

Product Data Sheet



Technical data

Plate size		140 x 110
Bolt hole spacing		105 x 75-80
Bolt hole Ø		11
Wheel Ø		200 mm (D)
Tyre width		50 mm (T2)
Load capacity		180 kg
Total height		235 mm (H)
Offset swivel castor		65 mm
unit weight		3,1 kg
Temperature resistance		-25 ° C
Temperature resistance to		200 ° C
tread and tyre hardness		80° Shore A
Bearing type:		Roller bearing

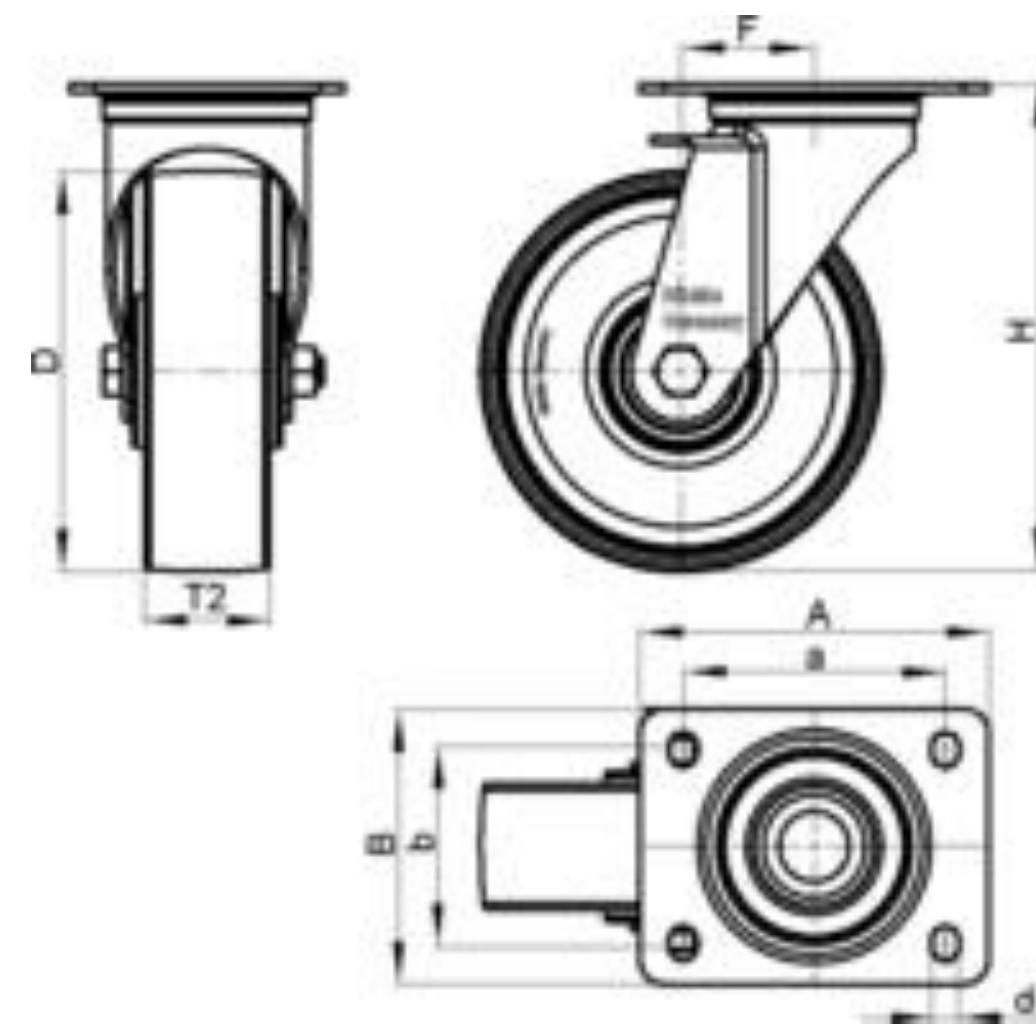

Product Data Sheet



Variants



LI-VEHI 200R-FI

Heat-resistant pressed steel swivel castor with top plate fitting and 'stop-fix' brake, Heat-resistant Blickle TempLine® Basic wheel with solid rubber tyres, with pressed steel rim