

Product Data Sheet



BK-ALBS 100K-1

EAN 4047526000066

ID 741972

Pressed steel fixed castor, medium heavy duty brackets, with top plate fitting, Heavy duty wheel with Blickle Besthane® Soft polyurethane tread, with aluminium wheel centre

Bracket:

Made of pressed steel. Bolted wheel axle. Zinc-plated, blue-passivated, Cr6-free.

Wheels:

Made of high-quality, reaction-injected polyurethane-elastomer Blickle Besthane® Soft, very high operational comfort through the especially thick, elastic tread, low-noise operation, very low rolling resistance, high dynamic load capacity, very good floor preservation, very high abrasion resistance, high cut and tear propagation resistance, very good chemical connection with the wheel centre.

Tread/tyre:

Made of high-quality polyurethane-elastomer Blickle Besthane® Soft, very low rolling resistance, high dynamic load capacity.

Tread colours blue

Wheel centre/rim:

Made of die-cast aluminium. Casted tread.

Wheel centre colour: silver grey

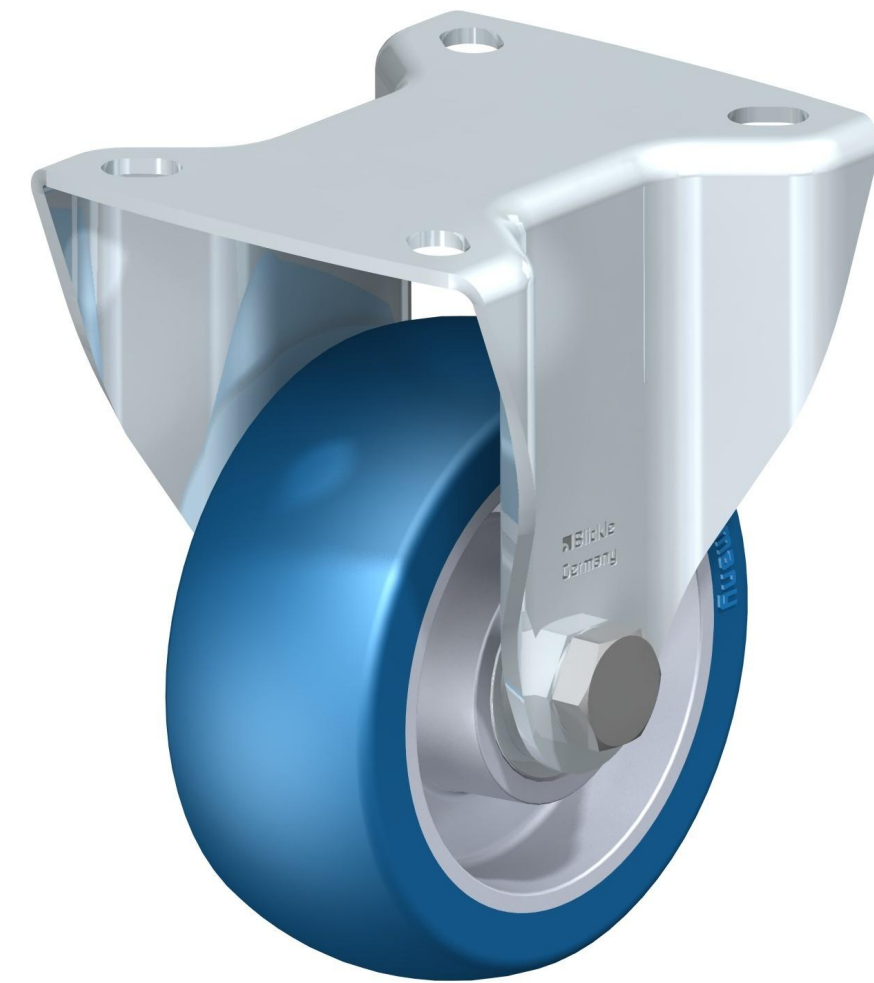

Rolling resistance

■■■■■ Excellent

Operating noise

■■■■□ Very good











Floor surface preservation

■■■■□ Very good

Product Data Sheet



Technical data

Plate size		100 x 85
Bolt hole spacing		80 x 60
Bolt hole Ø		9
Wheel Ø		100 mm (D)
Wheel width		40 mm (T2)
Load capacity		300 kg
Total height		130 mm (H)
unit weight		0,9 kg
Temperature resistance		-25 ° C
Temperature resistance to tread and tyre hardness		70 ° C
Bearing type:		Ball bearing

