

EA986KW-4



EAN: 4047526016555

ID: 16550

, Heavy duty nylon wheel

Bracket:

Sturdy welded steel construction, with double ball bearing in the swivel head, additionally reinforced by the integration of four specially shaped and hardened bearing seats, swivel head seal with labyrinth design, fitted grease nipple, bolted and secured with a welded very strong central kingpin. Bolted wheel axle. Zinc-plated, blue-passivated, Cr6-free.

Wheels:

Tyre & running tread: Made of high-quality, impact-resistant nylon, very rugged, heavy wheel design, very low rolling and swivelling resistance, smooth running performance on even floors, very high abrasion resistance. Tread colour:natural white

Rim / wheel centre: -

Variants:

mit Feststeller "stop-top"

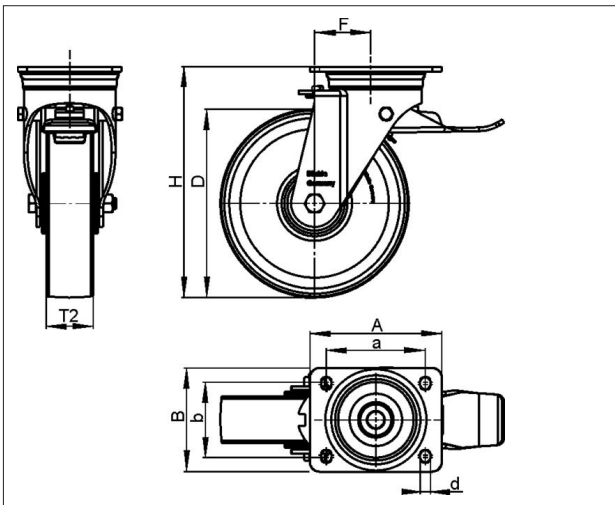

Technical data

Wheel Ø (D)	250 mm
Wheel width (T2)	65 mm
Load capacity	1200 kg
Total height (H)	295 mm
Offset swvl castor (F)	70 mm
Unit weight	6.85 kg
Temperature range from	-25 °C
Temperature range to	80 °C
Tread & tyre hardness	70° Shore D
Bearing type	
Plate size (A,B)	140 x 110 mm
Bolt hole Ø (d)	11 mm
Bolt hole spacing (a,b)	105 x 75-80 mm

Rolling resistance



Operating noise



Floor surface preservation

