

EA986LL-200



EAN: 4047526007553

ID: 7559

Stainless steel fixed castor with top plate fitting, Nylon wheel

Bracket:

Made of pressed high-quality, chromium-nickel stainless steel (Material No. 1.4301/AISI 304). All parts incl. axle material are corrosion-resistant. Bolted wheel axle. Vibration-ground finished.

Wheels:

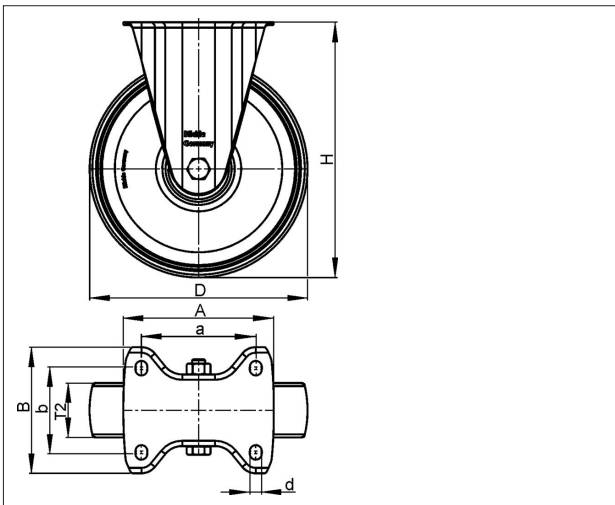

Tyre & running tread: Made of high-quality, impact-resistant nylon. Tread colour:natural white

Rim / wheel centre: -



Technical data

Wheel Ø (D)	200 mm
Wheel width (T2)	50 mm
Load capacity	300 kg
Total height (H)	235 mm
Unit weight	1.5 kg
Temperature range from	-25 °C
Temperature range to	80 °C
Tread & tyre hardness	70° Shore D
Bearing type	
Plate size (A,B)	140 x 110 mm
Bolt hole Ø (d)	11 mm
Bolt hole spacing (a,b)	105 x 75-80 mm

Rolling resistance	
Operating noise	
Floor surface preservation	