

EA986LM- 100



EAN: 4047526280017

ID: 280016

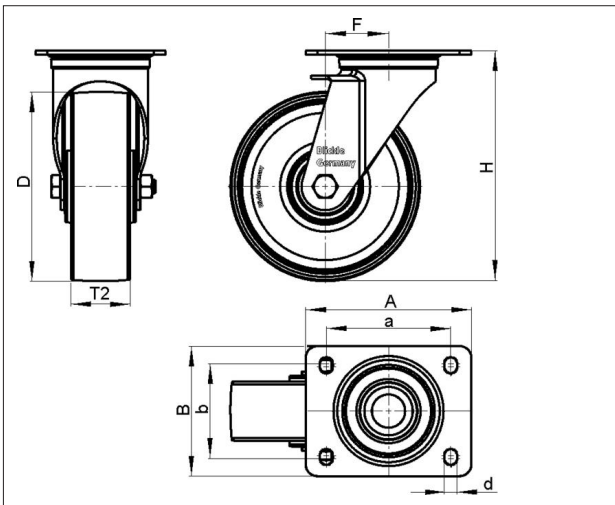

Nylon wheel

Tyre & running tread: Made of high-quality, impact-resistant nylon. Tread colour: natural white
Rim / wheel centre: -



Technical data

Wheel Ø (D)	100 mm
Wheel width (T2)	37 mm
Load capacity	150 kg
Total height (H)	125 mm
Offset swvl castor (F)	36 mm
Unit weight	0.59 kg
Temperature range from	-25 °C
Temperature range to	80 °C
Tread & tyre hardness	70° Shore D
Bearing type	
Plate size (A,B)	100 x 85 mm
Bolt hole Ø (d)	9 mm
Bolt hole spacing (a,b)	80 x 60 mm

Rolling resistance	
Operating noise	
Floor surface preservation	