

EA986MB- 125



EAN: 4047526005474

ID: 5470

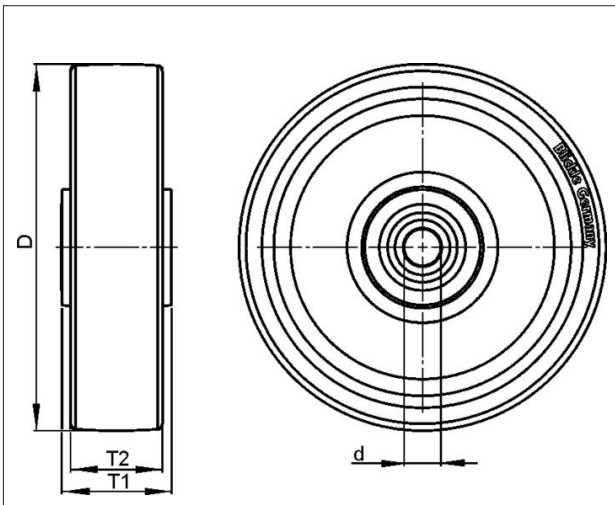

Nylon wheel

Tyre & running tread: Made of high-quality, impact-resistant nylon. Tread colour: natural white
Rim / wheel centre: -



Technical data

Wheel Ø (D)	125 mm
Wheel width (T2)	40 mm
Load capacity	300 kg
Axle bore Ø (d)	15 mm
Hub length (T1)	45 mm
Unit weight	0.231 kg
Temperature range from	-25 °C
Temperature range to	80 °C
Tread & tyre hardness	70° Shore D
Bearing type	

Rolling resistance	
Operating noise	
Floor surface preservation	