

EA986MB-250



EAN: 4047526005597

ID: 5595

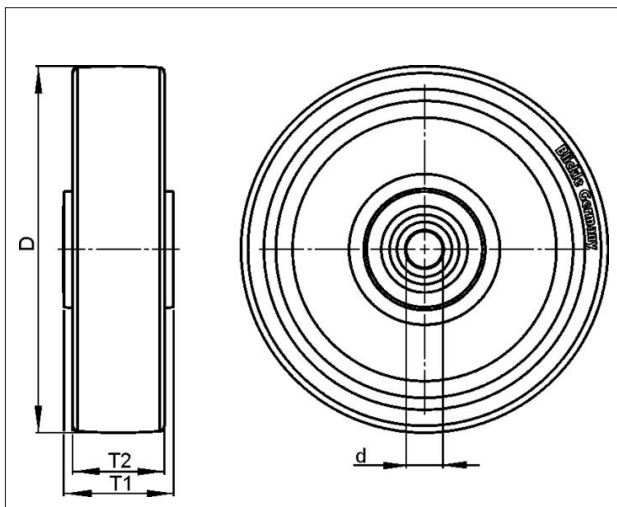

Nylon wheel

Tyre & running tread: Made of high-quality, impact-resistant nylon. Tread colour: natural white
Rim / wheel centre: -



Technical data

Wheel Ø (D)	250 mm
Wheel width (T2)	50 mm
Load capacity	1000 kg
Axle bore Ø (d)	25 mm
Hub length (T1)	60 mm
Unit weight	1.141 kg
Temperature range from	-25 °C
Temperature range to	80 °C
Tread & tyre hardness	70° Shore D
Bearing type	

Rolling resistance	
Operating noise	
Floor surface preservation	