

# EA986MB- 6



**EAN: 4047526005528**

**ID: 5520**

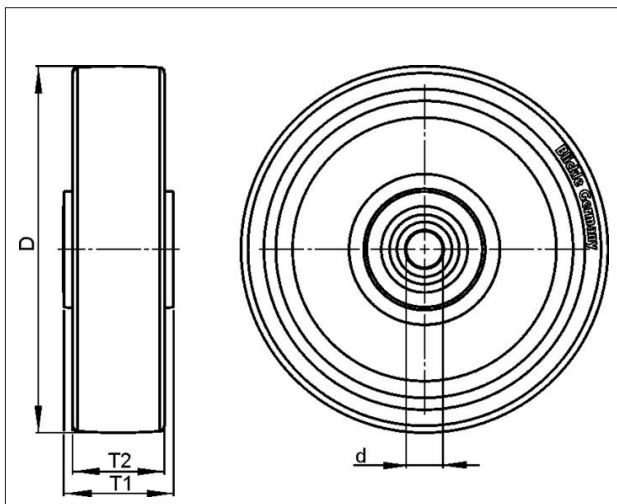

**Nylon wheel**

**Tyre & running tread:** Made of high-quality, impact-resistant nylon. Tread colour: natural white  
**Rim / wheel centre:** -



### Technical data

Wheel Ø (D)	150 mm
Wheel width (T2)	50 mm
Load capacity	400 kg
Axle bore Ø (d)	20 mm
Hub length (T1)	60 mm
Unit weight	0.7 kg
Temperature range from	-25 °C
Temperature range to	80 °C
Tread & tyre hardness	70° Shore D
Bearing type	

Rolling resistance	
Operating noise	
Floor surface preservation	