

EA986MC- 1



EAN: 4047526041908

ID: 41905

Wheel with standard solid rubber tyres, with synthetic rim

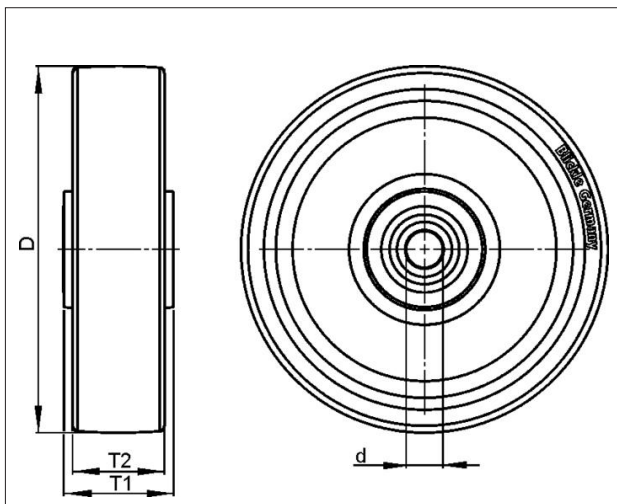

Tyre & running tread: Made of standard solid rubber, very high operational comfort, low-noise operation, very good floor preservation, PAH conform acc. to EU directive 2005/69/EC. Tread colour: black

Rim / wheel centre: Made of high-quality, impact-resistant polypropylene. Pressed-on tyre.

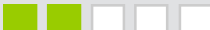

Technical data

Wheel Ø (D)	80 mm
Wheel width (T2)	25 mm
Load capacity	50 kg
Axle bore Ø (d)	12 mm
Hub length (T1)	35 mm
Unit weight	0.122 kg
Temperature range from	-20 °C
Temperature range to	60 °C
Tread & tyre hardness	80° Shore A
Bearing type	

Rolling resistance	
Operating noise	
Floor surface preservation	

Blickle Räder+Rollen GmbH u. Co. KG

Heinrich-Blickle-Straße 1 · 72348 Rosenfeld · Germany
 Telefon: +49 7428 932-0 · Telefax: +49 7428 932-209
 E-Mail: info@blickle.com · Internet: www.blickle.com

© Blickle Räder+Rollen GmbH u. Co. KG 2013
 Rosenfeld · Germany

VPP 80/12R

Variants



With non-marking grey
tyre