

EA986MD-100



EAN: 4047526006907

ID: 6908

Heavy duty nylon wheel

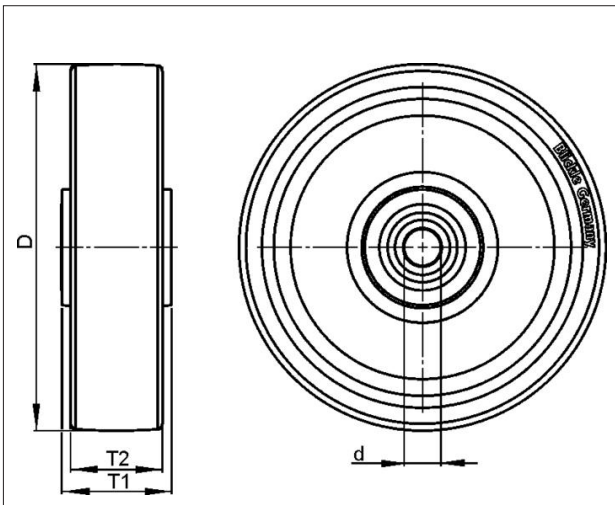

Tyre & running tread: Made of high-quality, impact-resistant nylon, very rugged, heavy wheel design, very low rolling and swivelling resistance, smooth running performance on even floors, very high abrasion resistance.
Tread colour:natural white

Rim / wheel centre: -



Technical data

Wheel Ø (D)	100 mm
Wheel width (T2)	37 mm
Load capacity	500 kg
Axle bore Ø (d)	15 mm
Hub length (T1)	45 mm
Unit weight	0.239 kg
Temperature range from	-25 °C
Temperature range to	80 °C
Tread & tyre hardness	70° Shore D
Bearing type	

Rolling resistance	
Operating noise	
Floor surface preservation	

Blickle Räder+Rollen GmbH u. Co. KG

Heinrich-Blickle-Straße 1 · 72348 Rosenfeld · Germany
 Telefon: +49 7428 932-0 · Telefax: +49 7428 932-209
 E-Mail: info@blickle.com · Internet: www.blickle.com

© Blickle Räder+Rollen GmbH u. Co. KG 2013
 Rosenfeld · Germany