

EA986MF-100



EAN: 4047526226053

ID: 226050

Wheel with solid rubber tyres, with synthetic rim

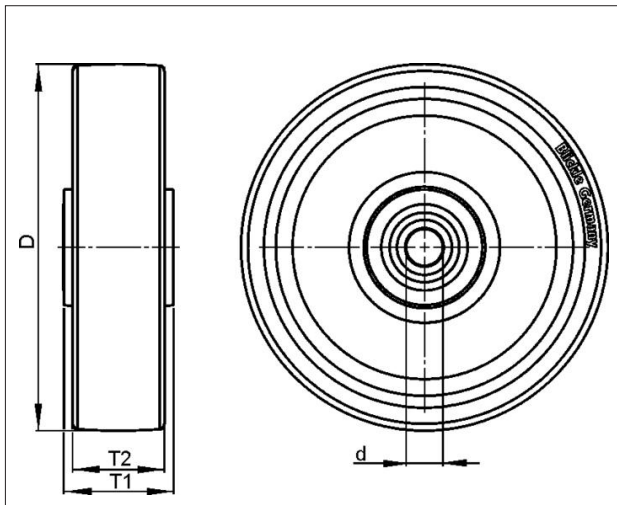

Tyre & running tread: Made of high-quality solid rubber, very high operational comfort, low-noise operation, very good floor preservation. Tread colour: grey

Rim / wheel centre: Made of high-quality, impact-resistant nylon. Pressed-on tyre.



Technical data

Wheel Ø (D)	100 mm
Wheel width (T2)	25 mm
Load capacity	90 kg
Axle bore Ø (d)	6 mm
Hub length (T1)	30 mm
Unit weight	0.222 kg
Temperature range from	-20 °C
Temperature range to	60 °C
Tread & tyre hardness	80° Shore A
Bearing type	

Rolling resistance	
Operating noise	
Floor surface preservation	

Blickle Räder+Rollen GmbH u. Co. KG

Heinrich-Blickle-Straße 1 · 72348 Rosenfeld · Germany
 Telefon: +49 7428 932-0 · Telefax: +49 7428 932-209
 E-Mail: info@blickle.com · Internet: www.blickle.com

© Blickle Räder+Rollen GmbH u. Co. KG 2013
 Rosenfeld · Germany

VPA 100/6K

Variants



Antistatic version