

EA986MG- 100



EAN: 4047526040956

ID: 40956

Wheel with standard solid rubber tyres, with pressed steel rim, reinforced design

Tyre & running tread: Made of standard solid rubber, very high operational comfort, low-noise operation, very good floor preservation, PAH conform acc. to EU directive 2005/69/EC. Tread colour: black

Rim / wheel centre: Pressed steel rim with tubular steel hub, bolted, zinc-plated, blue-passivated, Cr6-free.

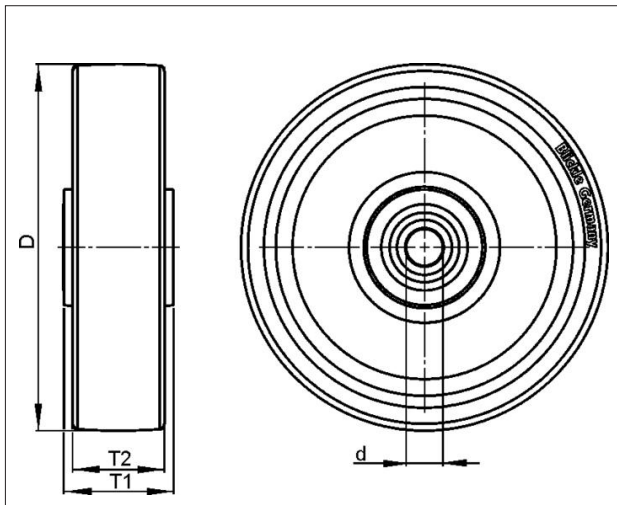

Technical data

Wheel Ø (D)	100 mm
Wheel width (T2)	30 mm
Load capacity	70 kg
Axle bore Ø (d)	15 mm
Hub length (T1)	45 mm
Unit weight	0.449 kg
Temperature range from	-25 °C
Temperature range to	80 °C
Tread & tyre hardness	80° Shore A
Bearing type	



Rolling resistance	
Operating noise	
Floor surface preservation	

Blickle Räder+Rollen GmbH u. Co. KG

Heinrich-Blickle-Straße 1 · 72348 Rosenfeld · Germany
 Telefon: +49 7428 932-0 · Telefax: +49 7428 932-209
 E-Mail: info@blickle.com · Internet: www.blickle.com

© Blickle Räder+Rollen GmbH u. Co. KG 2013
 Rosenfeld · Germany

V 100/15R

Variants	
	Antistatic version
	With non-marking grey tyre