

EA986MG-6



EAN: 4047526003036

ID: 3038

Wheels with 'Blickle Comfort' two-component solid rubber tyres, with pressed steel rim

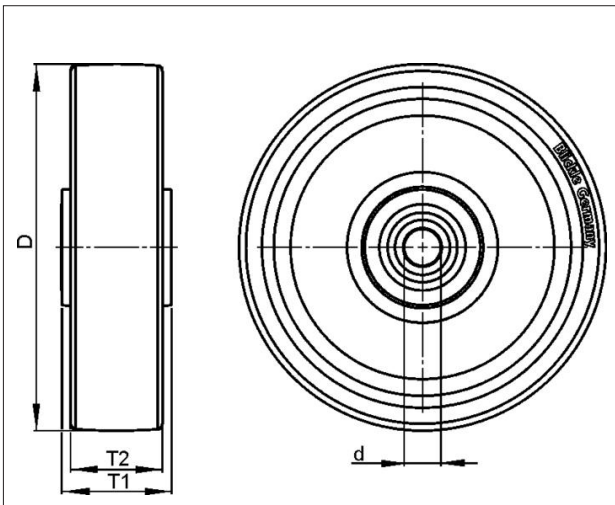

Tyre & running tread: Made of 'Blickle Comfort' two-component solid rubber, with hard rubber core and highly elastic rubber tread, very high operational comfort, low-noise operation, compared to standard solid rubber the operational comfort and the load capacity are increased whereas the rolling resistance is reduced, very good floor preservation. Tread colour: black

Rim / wheel centre: Pressed steel rim with tubular steel hub, pressed rim (special shock and impact-resistant design), zinc-plated, blue-passivated, Cr6-free. Tyre pressed with rim.



Technical data

Wheel Ø (D)	200 mm
Wheel width (T2)	50 mm
Load capacity	350 kg
Axle bore Ø (d)	20 mm
Hub length (T1)	60 mm
Unit weight	1.73 kg
Temperature range from	-25 °C
Temperature range to	80 °C
Tread & tyre hardness	65° Shore A
Bearing type	

Rolling resistance	
Operating noise	
Floor surface preservation	

Blickle Räder+Rollen GmbH u. Co. KG

Heinrich-Blickle-Straße 1 · 72348 Rosenfeld · Germany
 Telefon: +49 7428 932-0 · Telefax: +49 7428 932-209
 E-Mail: info@blickle.com · Internet: www.blickle.com

© Blickle Räder+Rollen GmbH u. Co. KG 2013
 Rosenfeld · Germany

RD 202/20R

Variants



With non-marking grey
tyre, 56° shore A