

EA986ML- 200



EAN: 4047526009601

ID: 9605

Heavy duty wheels made of cast nylon

Tyre & running tread: Made of high-quality, impact-resistant, hard and tough, highly compressed cast nylon with outstanding load capacity, very low rolling and swivelling resistance, smooth running performance on even floors, very high abrasion resistance. Tread colour: natural beige

Rim / wheel centre: -

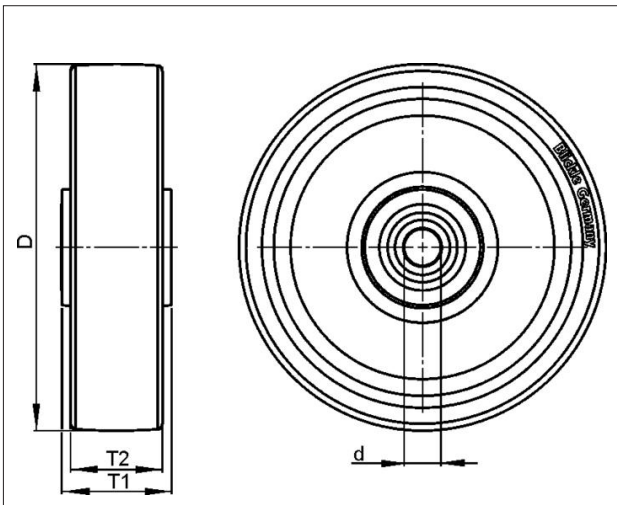

Technical data

Wheel Ø (D)	200 mm
Wheel width (T2)	55 mm
Load capacity	3000 kg
Axle bore Ø (d)	35 mm
Hub length (T1)	60 mm
Unit weight	2.717 kg
Temperature range from	-25 °C
Temperature range to	80 °C
Tread & tyre hardness	80° Shore D
Bearing type	

Rolling resistance	■ ■ ■ ■ ■
Operating noise	■ ■ □ □ □
Floor surface preservation	■ ■ □ □ □