

EA986ML-300



EAN: 4047526238650

ID: 238659

Heavy duty wheels made of cast nylon

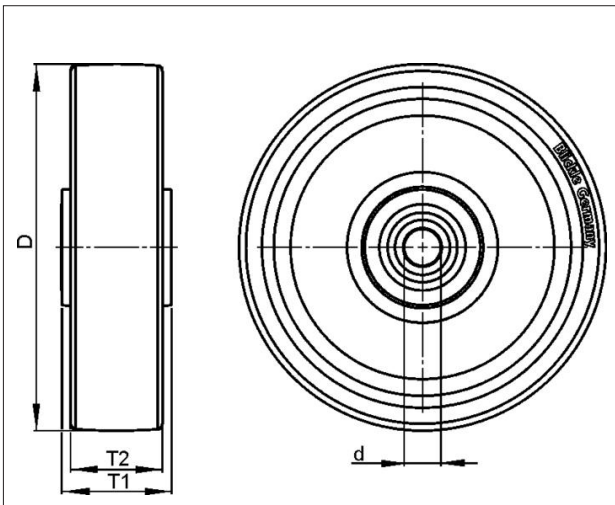

Tyre & running tread: Made of high-quality, impact-resistant, hard and tough, highly compressed cast nylon with outstanding load capacity, very low rolling and swivelling resistance, smooth running performance on even floors, very high abrasion resistance. Tread colour: natural beige

Rim / wheel centre: -



Technical data

Wheel Ø (D)	300 mm
Wheel width (T2)	80 mm
Load capacity	7000 kg
Axle bore Ø (d)	55 mm
Hub length (T1)	90 mm
Unit weight	8.69 kg
Temperature range from	-25 °C
Temperature range to	80 °C
Tread & tyre hardness	80° Shore D
Bearing type	

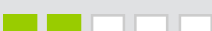
Rolling resistance	
Operating noise	
Floor surface preservation	

Blickle Räder+Rollen GmbH u. Co. KG

Heinrich-Blickle-Straße 1 · 72348 Rosenfeld · Germany
 Telefon: +49 7428 932-0 · Telefax: +49 7428 932-209
 E-Mail: info@blickle.com · Internet: www.blickle.com

© Blickle Räder+Rollen GmbH u. Co. KG 2013
 Rosenfeld · Germany