

EA986MP-125



EAN: 4047526265717

ID: 265710

Heavy duty wheel with Blickle Extrathane® polyurethane tread, with aluminium wheel centre

Tyre & running tread: Made of high-quality, reaction-injected polyurethane-elastomer Blickle Extrathane®, low-noise operation, low rolling resistance, good floor preservation, very high abrasion resistance, high cut and tear propagation resistance, very good chemical connection with the wheel centre. Tread colour: light brown

Rim / wheel centre: Made of die-cast aluminium. Casted tread.

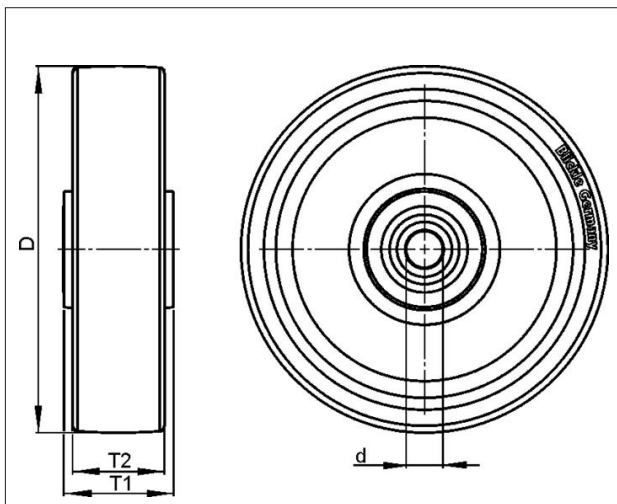

Technical data

Wheel Ø (D)	125 mm
Wheel width (T2)	40 mm
Load capacity	350 kg
Axle bore Ø (d)	15 mm
Hub length (T1)	45 mm
Unit weight	0.575 kg
Temperature range from	-25 °C
Temperature range to	70 °C
Tread & tyre hardness	92° Shore A
Bearing type	

Rolling resistance	<input checked="" type="checkbox"/> <input checked="" type="checkbox"/> <input checked="" type="checkbox"/> <input checked="" type="checkbox"/> <input type="checkbox"/>
Operating noise	<input checked="" type="checkbox"/> <input checked="" type="checkbox"/> <input checked="" type="checkbox"/> <input type="checkbox"/> <input type="checkbox"/>
Floor surface preservation	<input checked="" type="checkbox"/> <input checked="" type="checkbox"/> <input checked="" type="checkbox"/> <input type="checkbox"/> <input type="checkbox"/>

Blickle Räder+Rollen GmbH u. Co. KG

Heinrich-Blickle-Straße 1 · 72348 Rosenfeld · Germany
 Telefon: +49 7428 932-0 · Telefax: +49 7428 932-209
 E-Mail: info@blickle.com · Internet: www.blickle.com

© Blickle Räder+Rollen GmbH u. Co. KG 2013
 Rosenfeld · Germany

ALTH 125/15K

Variants



Antistatic version, non-marking grey