

EA986MV- 300



EAN: 4047526040680

ID: 40683

Wheel with pneumatic tyres, with synthetic rim

Tyre & running tread: Pneumatic tyre with tube, outstandingly high operational comfort, exceptionally high floor preservation, PAH conform acc. to EU directive 2005/69/EC. Tread colour: black

Rim / wheel centre: Made of high-quality, impact-resistant polypropylene. Tyre mounted on rim.

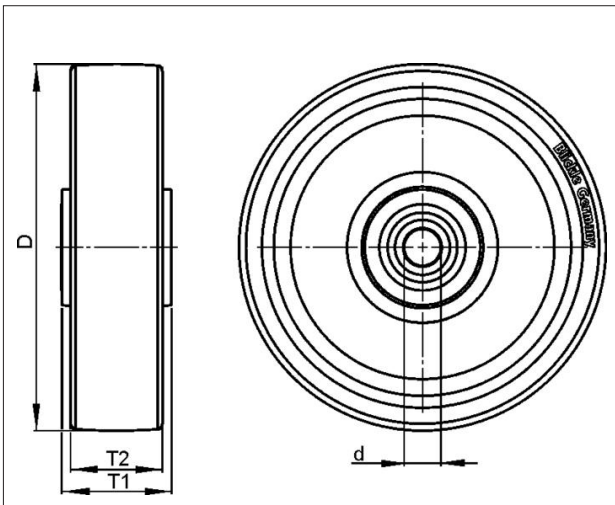

Technical data

Wheel Ø (D)	300 mm
Wheel width (T2)	100 mm
Tyre dimension	4.00-4
Ply-Rating	2
Profile	R01
Load capacity	180 kg
Tyre pressure	2,0/30 bar/psi
Axle bore Ø (d)	20 mm
Hub length (T1)	75 mm
Unit weight	1.1 kg
Temperature range from	-20 °C
Temperature range to	40 °C
Tread & tyre hardness	65° Shore A
Bearing type	

Rolling resistance



Operating noise



Floor surface preservation



Blickle Räder+Rollen GmbH u. Co. KG

Heinrich-Blickle-Straße 1 · 72348 Rosenfeld · Germany
 Telefon: +49 7428 932-0 · Telefax: +49 7428 932-209
 E-Mail: info@blickle.com · Internet: www.blickle.com

© Blickle Räder+Rollen GmbH u. Co. KG 2013
 Rosenfeld · Germany

PK 300/20-75G

Variants



Red centre