

# EA986MX-420



**EAN: 4047526257583**

**ID: 257584**

**Heavy duty wheel with pneumatic tyres**

**Tyre & running tread:** Pneumatic tyre with tube, outstandingly high operational comfort, exceptionally high floor preservation, PAH conform acc. to EU directive 2005/69/EC. Tread colour: black

**Rim / wheel centre:** Pressed steel rim, pressed and bolted, with welded tubular steel hub, zinc-plated, blue-passivated, Cr6-free.

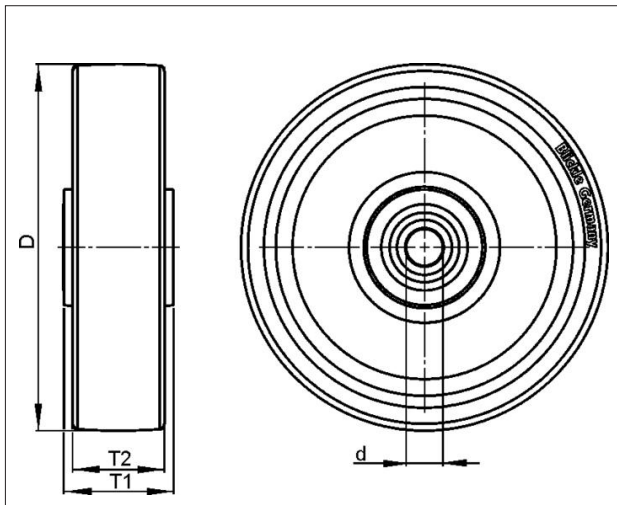

## Technical data

Wheel Ø (D)	420 mm
Wheel width (T2)	115 mm
Tyre dimension	4.00-8
Ply-Rating	6
Profile	B08
Load cap. with 4 km/h	650 kg
Load cap. with 25 km/h	500 kg
Tyre pressure	7,0/101 bar/psi
Axle bore Ø (d)	30 mm
Hub length (T1)	90 mm
Unit weight	8.591 kg
Temperature range from	-25 °C
Temperature range to	50 °C
Tread & tyre hardness	65° Shore A
Bearing type	

Rolling resistance



Operating noise



Floor surface preservation

