

EA986NA-125



EAN: 4047526007676

ID: 7674

Cast iron wheel

Tyre & running tread: Made of rugged grey cast iron, machined tread and tread edges, with grease nipple, exceptionally low rolling and swivel resistance, outstanding wear resistance, lacquered. Tread colour: silver grey
Rim / wheel centre: -

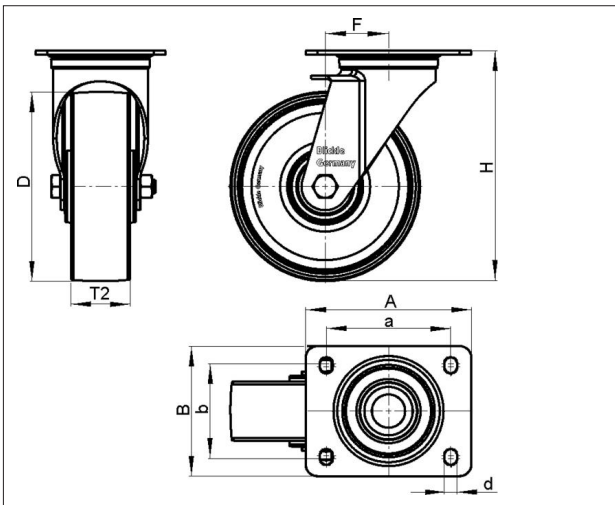

Technical data

Wheel Ø (D)	125 mm
Wheel width (T2)	35 mm
Load capacity	200 kg
Total height (H)	150 mm
Offset swvl castor (F)	40 mm
Unit weight	2.04 kg
Temperature range from	-25 °C
Temperature range to	120 °C
Tread & tyre hardness	180 - 220 HB
Bearing type	
Plate size (A,B)	100 x 85 mm
Bolt hole Ø (d)	9 mm
Bolt hole spacing (a,b)	80 x 60 mm

Rolling resistance	
Operating noise	
Floor surface preservation	

L-G 125G

Variants



With 'stop-top' brake