

EA986NA-4



EAN: 4047526080273

ID: 80275

, Cast iron wheel

Bracket:

Made of heavy pressed steel, with double ball bearing in the swivel head, strong central kingpin, swivel head seals. The special Blickle dynamic riveting process of the swivel head results in minimal swivel head play and smooth rolling characteristics with an increased service life achieved by the work hardening of the ball race grooves. Bolted wheel axle. Zinc-plated, blue-passivated, Cr6-free.

Wheels:

Tyre & running tread: Made of rugged grey cast iron, machined tread and tread edges, with grease nipple, exceptionally low rolling and swivel resistance, outstanding wear resistance, lacquered. Tread colour: silver grey

Rim / wheel centre: -

Variants:

mit Feststeller "stop-fix"

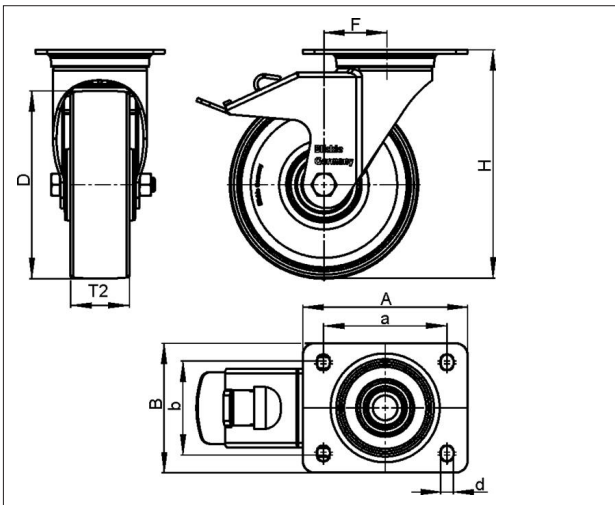

Technical data

Wheel Ø (D)	150 mm
Wheel width (T2)	50 mm
Load capacity	350 kg
Total height (H)	190 mm
Offset swvl castor (F)	60 mm
Unit weight	4.887 kg
Temperature range from	-25 °C
Temperature range to	120 °C
Tread & tyre hardness	180 - 220 HB
Bearing type	
Plate size (A,B)	140 x 110 mm
Bolt hole Ø (d)	11 mm
Bolt hole spacing (a,b)	105 x 75-80 mm

Rolling resistance



Operating noise



Floor surface preservation

