

EA986NM-100



EAN: 4047526584900

ID: 584904

Pressed steel fixed castor, heavy duty brackets, with top plate fitting, Extra heavy duty solid steel wheel

Bracket:

Made of pressed steel. Bolted wheel axle. Zinc-plated, blue-passivated, Cr6-free.

Wheels:

Tyre & running tread: Made of mild steel, with slightly crowned tread and lightly oiled surface, very low rolling and swivelling resistance, smooth running performance on even floors, extremely wear-resistant, particularly high static and dynamic load capacity. Tread colour: silver

Rim / wheel centre: -

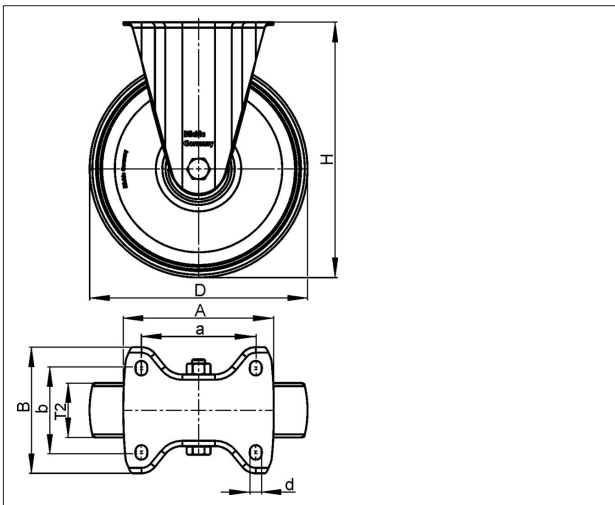

Technical data

Wheel Ø (D)	100 mm
Wheel width (T2)	40 mm
Load capacity	700 kg
Total height (H)	140 mm
Unit weight	2.8 kg
Temperature range from	-25 °C
Temperature range to	120 °C
Tread & tyre hardness	190 - 230 HB
Bearing type	
Plate size (A,B)	100 x 85 mm
Bolt hole Ø (d)	9 mm
Bolt hole spacing (a,b)	80 x 60 mm

Rolling resistance



Operating noise



Floor surface preservation

