

EA986RW-4



EAN: 4047526463748

ID: 463745

Guide roller with **Blickle Extrathane®** polyurethane tread

Tyre & running tread: Made of high-quality, reaction-injected polyurethane-elastomer **Blickle Extrathane®**, low-noise operation, low rolling resistance, good floor preservation, very high abrasion resistance, high cut and tear propagation resistance, tread directly injected onto the ball bearing, very good chemical connection. Tread colour: light brown
Rim / wheel centre: -

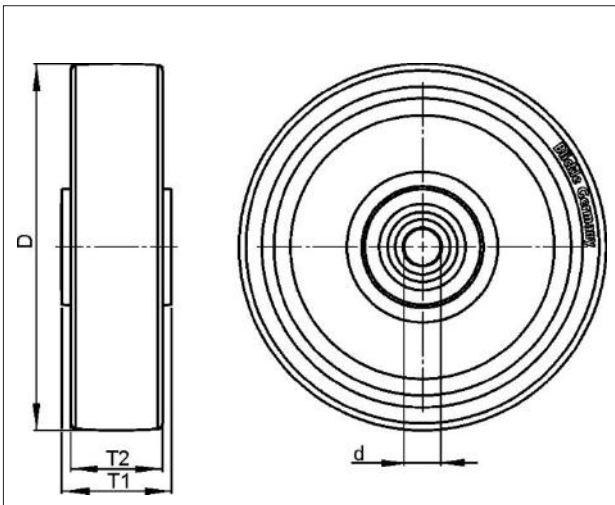

Technical data

Wheel Ø (D)	35 mm
Wheel width (T2)	14 mm
Load capacity	40 kg
Ball bearing	6001 2RS
Axle bore Ø (d)	12 mm
Clamping length (T5)	8 mm
Unit weight	0.027 kg
Temperature range from	-25 °C
Temperature range to	70 °C
Tread & tyre hardness	92° Shore A
Bearing type	

Rolling resistance	<input checked="" type="checkbox"/> <input checked="" type="checkbox"/> <input checked="" type="checkbox"/> <input checked="" type="checkbox"/> <input type="checkbox"/>
Operating noise	<input checked="" type="checkbox"/> <input checked="" type="checkbox"/> <input checked="" type="checkbox"/> <input type="checkbox"/> <input type="checkbox"/>
Floor surface preservation	<input checked="" type="checkbox"/> <input checked="" type="checkbox"/> <input checked="" type="checkbox"/> <input type="checkbox"/> <input type="checkbox"/>

Blickle Räder+Rollen GmbH u. Co. KG

Heinrich-Blickle-Straße 1 · 72348 Rosenfeld · Germany
 Telefon: +49 7428 932-0 · Telefax: +49 7428 932-209
 E-Mail: info@blickle.com · Internet: www.blickle.com

© Blickle Räder+Rollen GmbH u. Co. KG 2013
 Rosenfeld · Germany