

# EA986SC-150



**EAN: 4047526268213**

**ID: 268219**

**Extra heavy duty solid steel wheel**

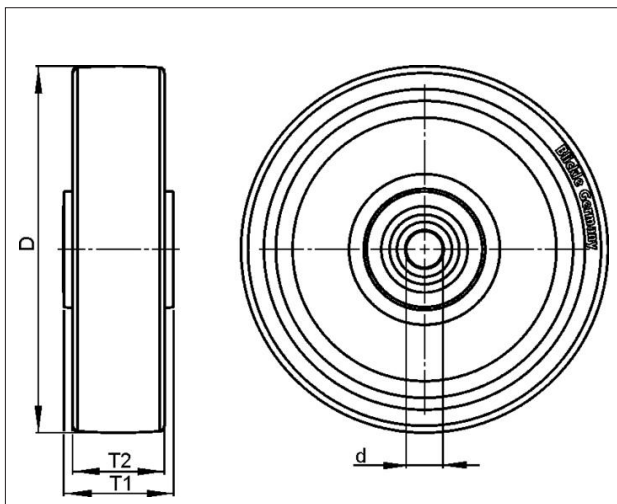

**Tyre & running tread:** Made of mild steel, with slightly crowned tread and lightly oiled surface, very low rolling and swivelling resistance, smooth running performance on even floors, extremely wear-resistant, particularly high static and dynamic load capacity. Tread colour: silver

**Rim / wheel centre:** -



### Technical data

Wheel Ø (D)	150 mm
Wheel width (T2)	55 mm
Load capacity	4000 kg
Axle bore Ø (d)	45 mm
Hub length (T1)	60 mm
Unit weight	6.131 kg
Temperature range from	-25 °C
Temperature range to	120 °C
Tread & tyre hardness	190 - 230 HB
Bearing type	

Rolling resistance	
Operating noise	
Floor surface preservation	

**Blickle Räder+Rollen GmbH u. Co. KG**

Heinrich-Blickle-Straße 1 · 72348 Rosenfeld · Germany  
 Telefon: +49 7428 932-0 · Telefax: +49 7428 932-209  
 E-Mail: info@blickle.com · Internet: www.blickle.com

© Blickle Räder+Rollen GmbH u. Co. KG 2013  
 Rosenfeld · Germany