

## Product Data Sheet



### SPK 125K

EAN 4047526008505

ID 8508

#### Cast iron flanged wheel

##### Wheels:

Made of rugged grey cast iron, with grease nipple, machined tread with horizontal taper of 3°, exceptionally low rolling resistance, outstanding wear resistance, lacquered.

**Tread colours:** silver

**Wheel centre/rim: - Wheel centre colour:** silver

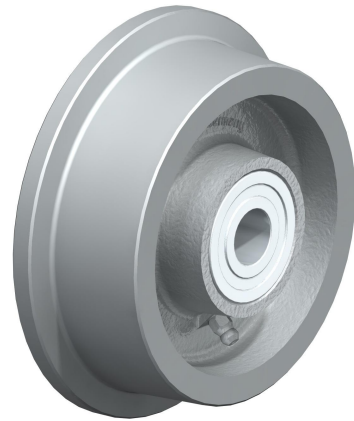

##### Rolling resistance

■ ■ ■ ■ ■ Excellent

##### Operating noise

■ □ □ □ □ Sufficient













##### Floor surface preservation

■ □ □ □ □ Sufficient

# Product Data Sheet



## Technical data

Wheel Ø w/o flange		125 mm (D)
Wheel Ø incl. flange		145 mm (D1)
Wheel width		46 mm (T2)
Tread width		36 mm (T3)
Flange length		13 mm (T4)
Load capacity		900 kg
Axle bore Ø		20 mm (d)
Hub length		52 mm (T1)
unit weight		3,2 kg
Temperature resistance		-25 ° C
Temperature resistance to		120 ° C
tread and tyre hardness		180 - 220 HB
Bearing type		Ball bearing

