

EA986SF-75



EAN: 4047526608309

ID: 608307

Solid steel flanged wheel

Tyre & running tread: Made of mild steel, with lightly oiled surface, tread with horizontal taper of 3°, very low rolling resistance, extremely wear-resistant, particularly high static and dynamic load capacity. Tread colour: silver
Rim / wheel centre: -

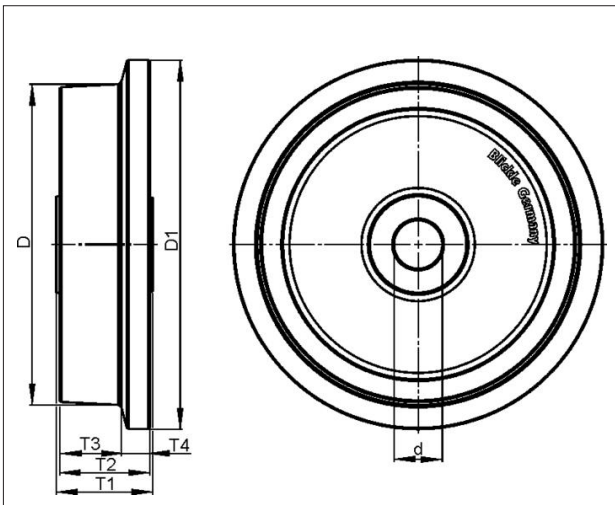

Technical data

Wheel Ø (D)	75 mm
Wheel Ø incl. flange (D1)	100 mm
Wheel width (T2)	40 mm
Tread width without flange (T3)	30 mm
Load capacity	800 kg
Axle bore Ø (d)	20 mm
Hub length (T1)	40 mm
Unit weight	1.3 kg
Temperature range from	-25 °C
Temperature range to	120 °C
Tread & tyre hardness	190 - 230 HB
Bearing type	

Rolling resistance



Operating noise



Floor surface preservation

